

miriac SBC-LS1046A

User Manual (CRX05 Revision 2)

V 2.4

Table of Contents

1	General Notes	4	5.4	Clock Distribution.....	26
1.1	Warranty.....	4	5.5	Boot Configuration.....	28
1.2	Links.....	4	5.6	NAND Flash.....	29
1.3	Liability.....	4	5.7	QSPI Flash.....	30
1.4	Offer to Provide Source Code of Certain Software.....	5	5.8	I ² C Bus.....	31
1.5	Symbols, Conventions and Abbreviations.....	6	5.8.1	I2C-1.....	31
1.5.1	Symbols.....	6	5.8.2	I2C-2.....	32
1.5.2	Conventions.....	6	6	Peripherals	34
2	Introduction	7	6.1	Connector References.....	34
2.1	Safety and Handling Precautions.....	7	6.2	Module Connector.....	35
2.2	Short Description.....	8	6.3	LAN Connections.....	35
2.3	Shipping List.....	8	6.3.1	Port 1.....	36
2.4	Feature Changelist for HW Revisions.....	8	6.3.2	Port 2.....	36
2.4.1	Changes from revision 2 to revision 3.....	8	6.3.3	Port 3.....	37
2.4.2	Changes from revision 1 to revision 2.....	9	6.3.4	Port 4.....	37
2.5	Functional Coverage.....	10	6.4	PCIe Connections.....	38
3	Quick Start Guide	11	6.4.1	Mini-PCIe Slot.....	38
3.1	Prerequisites.....	11	6.4.2	Mini-PCIe Slot / mSATA Slot.....	40
3.1.1	Minimum Requirements.....	11	6.4.3	PCIe Extension Connector 1.....	42
3.1.2	Recommended Items.....	11	6.4.4	PCIe Extension Connector 2.....	43
3.2	Board Preparation and Power-Up.....	12	6.4.5	PCIe with external clock.....	44
3.3	Operation.....	13	6.5	SATA.....	45
3.3.1	U-Boot Startup.....	13	6.6	MicroSD Card Slot.....	46
3.3.2	Linux.....	14	6.7	USB.....	47
4	System Description	15	6.7.1	USB1.....	47
4.1	Block Diagram.....	15	6.7.2	USB2.....	48
4.2	Feature Overview.....	15	6.7.3	USB3.....	49
4.3	Mechanical Dimensions.....	17	6.8	UART.....	50
4.3.1	MPX-LS1046A.....	17	6.9	MCU Connector.....	51
4.3.2	SBC-LS1046A.....	18	6.10	JTAG Connector.....	52
4.4	Connector Layout – Top.....	19	6.10.1	JTAG on Revision R3.....	52
4.5	Connector Layout – Bottom.....	20	6.10.2	JTAG on Revision R2.....	53
4.6	Power Supply.....	21	6.11	Aurora Connectors (optional).....	54
4.6.1	Input Supply Rating.....	21	6.12	General Purpose Inputs / Outputs.....	55
4.6.2	Input Power Connector.....	21	6.13	Fan Connector.....	57
4.6.3	Power Supply Structure.....	21	6.14	Smart Card Connector.....	58
4.6.4	RTC Backup Battery.....	22	6.15	emBRICK Connector.....	59
4.6.5	Current Measurement.....	23	7	Switches, Buttons and Jumpers	60
4.6.6	Fuses.....	23	7.1	Boot Device Switch.....	60
5	System Core, Boot Configuration and On-Board Memory	24	7.2	Board Configuration Switch.....	61
5.1	Processor NXP LS1046A.....	24	7.3	PCIe selection: root complex / endpoint.....	61
5.2	JTAG Chain.....	24	7.4	Reset Button.....	62
5.3	Reset Structure.....	24	8	LEDs	63
			8.1	RJ45 LEDs.....	63

8.2	Power And Reset LEDs.....	64	10	Appendix	67
8.3	RGB LEDs.....	65	10.1	Acronyms.....	67
9	Software	66	10.2	Table of Figures.....	68
9.1	U-Boot	66	10.3	Table of Tables.....	68
9.2	Operating System Support	66	11	History	70

1 General Notes

Copyright MicroSys Electronics GmbH, January 2017

All rights reserved. All rights in any information which appears in this document belong to MicroSys Electronics GmbH or our licensors. You may copy the information in this manual for your personal, non-commercial use.

Copyrighted products are not explicitly indicated in this manual. The absence of the copyright (©) and trademark (TM or ®) symbols does not imply that a product is not protected. Additionally, registered patents and trademarks are similarly not expressly indicated in this manual.

1.1 Warranty

To the extent permissible by applicable law all information in this document is provided without warranty of any kind, whether expressed or implied, including but not limited to any implied warranty of satisfactory quality or fitness for a particular purpose, or of non-infringement of any third party's rights. We try to keep this document accurate and up-to-date but we do not make any warranty or representation about such matters. In particular we assume no liability or responsibility for any errors or omissions in this document.

MicroSys Electronics GmbH neither gives any guarantee nor accepts any liability whatsoever for consequential damages resulting from the use of this manual or its associated product.

MicroSys Electronics GmbH further reserves the right to alter the layout and/or design of the hardware without prior notification and accepts no liability for doing so.

1.2 Links

We make no warranty about any other sites that are linked to or from this document, whether we authorize such links or not.

1.3 Liability

To the extent permissible by applicable law, in no circumstance, including (but not limited to) negligence, shall we be liable for your reliance on any information in this document, nor shall we be liable for any direct, incidental, special, consequential, indirect or punitive damages nor any loss of profit that result from the use of, or the inability to use, this document or any material on any site linked to this document even if we have been advised of the possibility of such damage. In no event shall our liability to you for all damages, losses and causes of action whatsoever, whether in contract, tort (including but not limited to negligence) or otherwise exceed the amount, if any, paid by you to us for gaining access to this document.

MicroSys Electronics GmbH
Muehlweg 1
D-82054 Sauerlach
Germany

Phone: +49 8104 801-0
Fax: +49 8104 801-110

1.4 Offer to Provide Source Code of Certain Software

This product contains copyrighted software that is licensed under the General Public License (“GPL”) and under the Lesser General Public License Version (“LGPL”). The GPL and LGPL licensed code in this product is distributed without any warranty. Copies of these licenses are included in this product.

You may obtain the complete corresponding source code (as defined in the GPL) for the GPL Software, and/or the complete corresponding source code of the LGPL Software (with the complete machine-readable “work that uses the Library”) for a period of three years after our last shipment of the product including the GPL Software and/or LGPL Software, which will be no earlier than December 1, 2010, for the cost of reproduction and shipment, which is dependent on the preferred carrier and the location where you want to have it shipped to, by sending a request to:

MicroSys Electronics GmbH
Muehlweg 1
D-82054 Sauerlach
Germany

In your request please provide the product name and version for which you wish to obtain the corresponding source code and your contact details so that we can coordinate the terms and cost of shipment with you.

The source code will be distributed WITHOUT ANY WARRANTY and licensed under the same license as the corresponding binary/object code.

This offer is valid to anyone in receipt of this information.

MicroSys Electronics GmbH is eager to duly provide complete source code as required under various Free Open Source Software licenses. If however you encounter any problems in obtaining the full corresponding source code we would be much obliged if you give us a notification to the email address gpl@microsys.de, stating the product and describing the problem (please do NOT send large attachments such as source code archives etc to this email address)

1.5 Symbols, Conventions and Abbreviations

1.5.1 Symbols

Throughout this document, the following symbols will be used:



Information marked with this symbol *MUST* be obeyed to avoid the risk of severe injury, health danger, or major destruction of the unit and its environment



Information marked with this symbol *MUST* be obeyed to avoid the risk of possible injury, permanent damage or malfunction of the unit.



Information marked with this symbol gives important hints upon details of this manual, or in order to get the best use out of the product and its features.

Table 1-1 Symbols

1.5.2 Conventions

Symbol	explanation
#	denotes a low active signal
←	denotes the signal flow in the shown direction
→	denotes the signal flow in the shown direction
↔	denotes the signal flow in both directions
→	denotes the signal flow in the shown direction with additional logic / additional ICs in the signal path
I/O	denotes a bidirectional pin
Input	denotes an input pin
matched	denotes the according signal to be routed impedance controlled and length matched
Output	denotes an output pin
Pin 1	refers to the numeric pin of a component package
Pin a1	refers to the array position of a pin within a component package
XXX-	denotes the negative signal of a differential pair
XXX+	denotes the positive signal of a differential pair
XXX	denotes an optional not mounted or fitted part

Table 1-2 Conventions

2 Introduction

Thank you for choosing the MicroSys SBC-LS1046A Single Board Computer system. This manual should help you to get the best performance and details out all of its features.

2.1 Safety and Handling Precautions



ALWAYS use the correct type and polarity of the power supply!

DO NOT exceed the rated maximum values for the power supply! This may result in severe permanent damage to the unit, as well as possible serious injury.

ALWAYS keep the unit dry, clean and free of foreign objects. Otherwise, irreparable damage may occur.



Parts of the unit may become hot during operation. Take care not to touch any parts of the circuitry during operation to avoid burns, and operate the unit in a well-ventilated location. Provide an appropriate cooling solution as required.



ALWAYS take care of ESD-safe handling!

Many pins on external connectors are directly connected to the CPU or other ESD sensitive devices.

Make or break ANY connections ONLY while the unit is switched OFF.

Otherwise, permanent damage to the unit may occur, which is not covered by warranty.



There is no separate SHIELD connection.

All the metal sheaths of shielded connectors are connected to GND.

Also, all mounting holes of the carrier board are connected to GND.

The module's mounting holes are not connected to GND

Take this into account when handling and mounting the unit.

Table 2-1 Safety and Handling Precautions

2.2 Short Description

The SBC-LS1046A is a small computer system consisting of

- the MPX-LS1046A module, based on NXP's LS1046A Multicore Communications Processors
- and the CRX05 carrier board.

It targets both

- evaluation of the respective MPX-LS1046A SOM
- direct usage as an industrial computing solution

This document gives you an overview on the board's connectors and how to take the first steps on the initial setup.

2.3 Shipping List

The SBC-LS1046A EvalKit package contains the following items:

- The SBC-LS1046A system, mounted with cooling solution
- Power Supply 12V DC stabilized / 2 A
- Cable adapter for the power supply
- USB cable type A – mini B
- Micro-SD-Card with U-Boot and root file system

2.4 Feature Changelist for HW Revisions

2.4.1 Changes from revision 2 to revision 3

The revision 3 of the carrier board provides following changes:

- Added SW4 to switch between root complex and endpoint
- Added 2 header for GND interconnection (JP1, JP2)
- Added buffer to SPI-CLK
- Added possibility to modify board to run with external PCIe-clock, requires hardware modification (default assembled to use internal clock)
- Type of "JTG-connector" changed to JST-BM14B-SRSS-TB

2.4.2 Changes from revision 1 to revision 2

The revision 2 of the carrier board provides new features:

- Added LED driver with 4x RGB LEDs
- Added 12 GPIOs (6x in / 6x out) addressable via I²C
 - Output voltage level maximum 24V (according to the input voltage of the carrier board)
 - Input voltage range 24V maximum
- Added SuperCap for RTC backup battery (CR2032 coin cell as assembly option still available)
- Added prerequisites for support of emBRICK devices
- Added current shunt for current measurements
- Added optional (by assembly option) support for onboard current measurements of the CPU module consumption via I²C current sense amplifier
- Added LAN interrupt support
- Added SMART CARD connector
- Added optional (by assembly option) extension connector (for example for additional GPIOs or graphic support if provided by the CPU)
- Added mounting holes for the carrierboard
- Added a fan connector
- Added connector labeling (silkscreen) on the PCB

Some features were changed:

- SerDes 6 and SerDes 7 lanes were swapped in order to achieve a wider functional coverage within the MPX2 module family
 - SerDes 6 is now connected to the SATA connector (ST10)
 - SerDes 7 is now connected to the mPCIe / mSATA slot (ST7)
- Improved power input section with filters
- Improved mechanical mounting of the CPU module and mPCIe/ mSATA cards
- Replaced PCIe x1 edge card connector with second PCIe extension connector

2.5 Functional Coverage

The following table shows the coverage achieved by the SBC-LS1046A compared to the features which are available on the carrierboard:

Interfaces provided by CRX05 carrierboard		Interfaces available with the SBC-LS1046A
SerDes 0	PCIe	✓
SerDes 1	SGMII	✓
SerDes 2	SGMII	✓
SerDes 3	SGMII	✓
SerDes 4	mPCIe / Aurora	✓ (mPCIe)
SerDes 5	PCIe	✓
SerDes 6	SATA	-
SerDes 7	mPCIe / mSATA	✓
RGMII 1	PHY	✓
USB 1	2.0 / 3.0	✓ (3.0)
USB 2	2.0 / 3.0	✓ (3.0)
SD-Card	1bit / 4 bit & boot device	✓
UART 1	UART to USB (debug console)	✓
UART 2	TTL only	✓
I ² C 1	Multiple devices	✓
I ² C 2	Multiple devices	✓
JTAG	Signals on non-standard connector	✓
Watchdog	Hardware watchdog with trigger signal from module	✓
RTC backup	Supercap	✓
Manual Reset	Button	✓
Reset LEDs	2x red	✓
Power LED	1x green	✓

Table 2-2 Functional coverage

3 Quick Start Guide

3.1 Prerequisites



***Always make sure to handle the SBC-LS1046A unit ESD-safe!
Otherwise, the unit may suffer permanent damage.
However, do not place the unit directly flat on a metal surface,
as this may result in short circuits and damage to the board.***

At first time operation unpack the unit and make sure that is clean and free of visible damage or foreign objects.

3.1.1 Minimum Requirements

To operate the board, you will at least need the following items:

- an adequate power supply, delivering 12V DC (stabilized) / 2A minimum.
- an USB cable (type A – mini B) adapted to connector ST5
- a serial terminal, such as a PC with an USB port running a terminal Software (e.g. TeraTerm, HyperTerminal, putty, Kermit...), or else a hardware serial console. **Choose the following parameters:**
 - (a) **115200 Bd**
 - (b) **8 Data bits**
 - (c) **No parity**
 - (d) **1 Stop Bit**

3.1.2 Recommended Items

The following items are not absolutely necessary, but strongly recommended for practical operation and development purposes:

- Network connection via Port4 to your local network installation
- TFTP server available for downloading within the network (Hint: may run on the same PC as the serial Terminal)
- SATA HDD/SSD and/or SD card as mass storage and/or boot media

3.2 Board Preparation and Power-Up

- Make sure the switches SW1 and SW2 are set properly in order to select the correct boot source and board configuration
- The board comes preconfigured to boot correctly on arrival.
- Connect the mini USB cable to ST5.
- Connect other peripherals (USB, LAN, SATA, ...) as far as intended.
- Connect the power line to the ST3 connector, while the power supply is still switched off.
- Switch on the power.

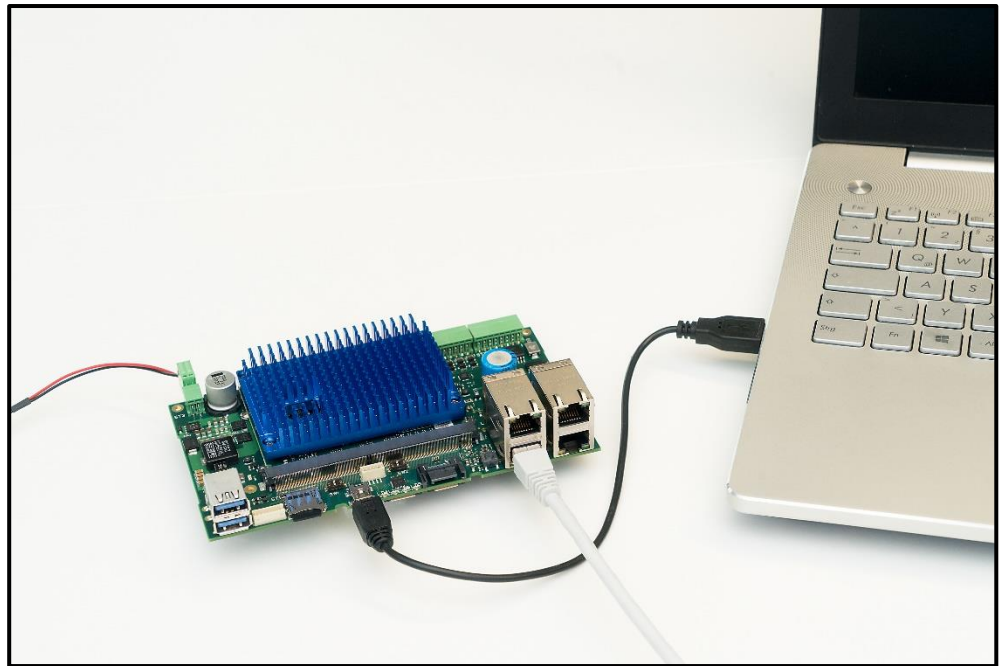

Figure 3-1 System setup example (LAN port 4)

3.3 Operation



**After Power-up, the green LED on the module should light up and any red LED should be off.
IF NOT, DISCONNECT THE UNIT FROM POWER AND CHECK FOR FAULTS!**

3.3.1 U-Boot Startup

When power is supplied the system will start.

On startup, U-Boot will come up similar to the following:



The exact output may vary, depending on U-Boot and MPX-LS1046A module versions in use.

```
U-Boot SPL 2016.09 (Feb 02 2017 - 08:47:06)
Initializing DDR....
Trying to boot from MMC1
```

```
U-Boot 2016.09 (Feb 02 2017 - 08:47:06 +0100)
```

```
SoC: LS1046AE Rev1.0 (0x87070010)
```

```
Clock Configuration:
```

```
    CPU0 (A72):1600 MHz   CPU1 (A72):1600 MHz   CPU2 (A72):1600
MHz
```

```
    CPU3 (A72):1600 MHz
```

```
    Bus:          600 MHz   DDR:          1600 MT/s   FMAN:          800
MHz
```

```
Reset Configuration Word (RCW):
```

```
    00000000: 0c100010 0c000000 00000000 00000000
    00000010: 33335559 00000012 60040000 41002000
    00000020: 00000000 00000000 00000000 01036ffc
    00000030: 20124000 00181208 00000096 00000001
```

```
Model: MPXLS1046 Board
```

```
Board: MPXLS1046, boot from SD
```

```
I2C:   ready
```

```
DRAM:  Detected UDIMM Fixed DDR on board
```

```
2 GiB (DDR4, 64-bit, CL=11, ECC on)
```

```
SEC0:  RNG instantiated
```

```
SEC Firmware: Bad firmware image (not a FIT image)
```

```
Waking secondary cores to start from ffd0f000
```

```
All (4) cores are up.
```

```
Using SERDES1 Protocol: 13107 (0x3333)
```

```
Using SERDES2 Protocol: 21849 (0x5559)
```

```
NAND: 512 MiB
MMC: FSL_SDHC: 0
In: serial
Out: serial
Err: serial
SATA link 0 timeout.
AHCI 0001.0301 32 slots 1 ports 6 Gbps 0x1 impl SATA mode
flags: 64bit ncq pm clo only pmp fbss pio slum part ccc apst
Found 0 device(s).
SCSI: Net:
MMC read: dev # 0, block # 2080, count 128 ...
Fman1: Uploading microcode version 106.4.15
Could not get PHY for FSL_MDIO0: addr 3
Failed to connect
Could not get PHY for FSL_MDIO0: addr 2
Failed to connect
PCIE0: pcie@3400000 Root Complex: no link
PCIE1: pcie@3500000 Root Complex: no link
PCIE2: pcie@3600000 Root Complex: no link
FM1@DTSEC3 [PRIME], FM1@DTSEC5, FM1@DTSEC6, FM1@DTSEC9
=>
```

3.3.2 Linux

For detailed setup instructions, refer to the readme document delivered along with the unit!

4 System Description

This section describes all parts of the SBC-LS1046A system.

4.1 Block Diagram

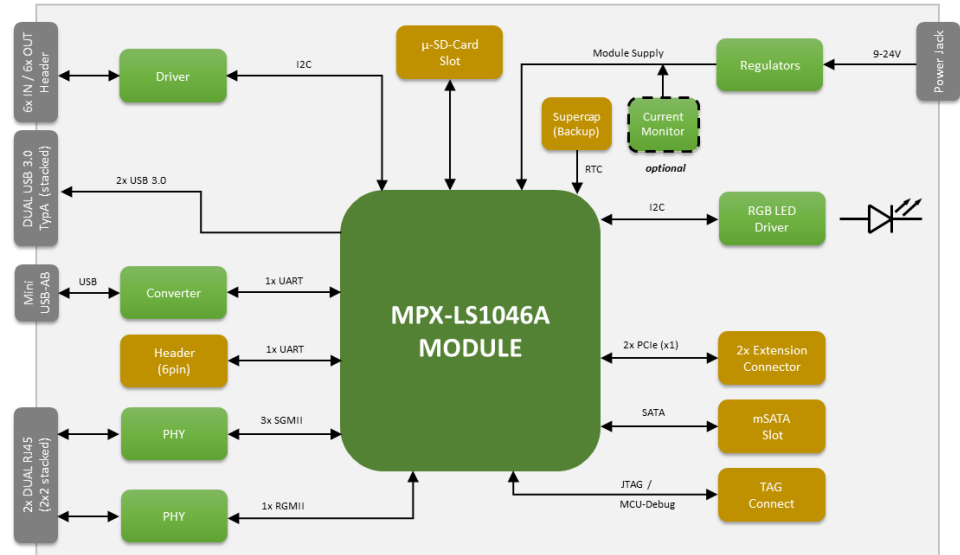

SBC-LS1046A: Version 2.0.0 – 2017-09-29

Figure 4-1 Block Diagram (MPX-LS1046A Revision 2 on carrier CRX05 Revision 2)

4.2 Feature Overview

The SBC-LS1046A offers the following features:

QorIQ ARM Cortex A72 cores 4xCPU Processor		
SDRAM	64-bit DDR4 interface	Default: 2GByte up to 4GByte up to 2100MT/s 4 x DDR4 (x16) single bank
Synchronous Memory	8-bit NAND Flash	Default: 512 MB up to 2 GByte
Hard Disk Drives Interface	SATA 3.0	mSATA slot
PCI Express port	3.0 / 8Gbps Lane x1 Root complex operations	2x PCIe extension connector
	3.0 / 8Gbps Lane x1 Root complex operations	1x mSata / Mini PCIe Slot
	3.0 / 8Gbps Lane x1 Root complex operations	1x Mini PCIe Slot
USB	USB 3.0 Phy	USB connector type A

QorIQ ARM Cortex A72 cores 4xCPU Processor		
	USB 3.0 Phy	USB connector type A
Expansion Cards	MMC/SD/SDIO	micro SD card holder
Serial Interfaces	UART1	Converted to USB (FT232), Available on USB connector type mini B
	UART2	4-wire Extension Port LVTTTL
I2C	I2C-1	400 kbps Connected Devices: TMP451AIDQF Temperature Sensor 2x BR24G128NUX-3 EEPROM RX-8803 RTC IDT6V49205B Clock Generator TLC59116 RGB LED Driver MAX7325 GPIO Port Expander
	I2C-2	400 kbps Connected Devices: SC18IS602BIPW I2C-to-SPI Bridge MAX9611AUB Current monitor TCA9544APWR I ² C Multiplexer
Gigabit Ethernet Controller	RGMII	10/100/1000 Mbps
	SGMII	10/100/1000 Mbps
	SGMII	10/100/1000 Mbps
	SGMII	10/100/1000 Mbps
System JTAG Controller	JTAG	Different connector on CRX05-R2 and R3
Power Management	Primary Supply	LM25116MH Input: 9-30V DC Output: 5V DC / peak 8A
	Backup Supply (RTC backup)	Supercap

Table 4-1 Feature Overview

4.3 Mechanical Dimensions

4.3.1 MPX-LS1046A

The following drawing shows the mechanical outline of the MPX-LS1046A module that is plugged in the CRX05 carrier board.



This drawing is not to scale.



For 3D data files please contact MicroSys.

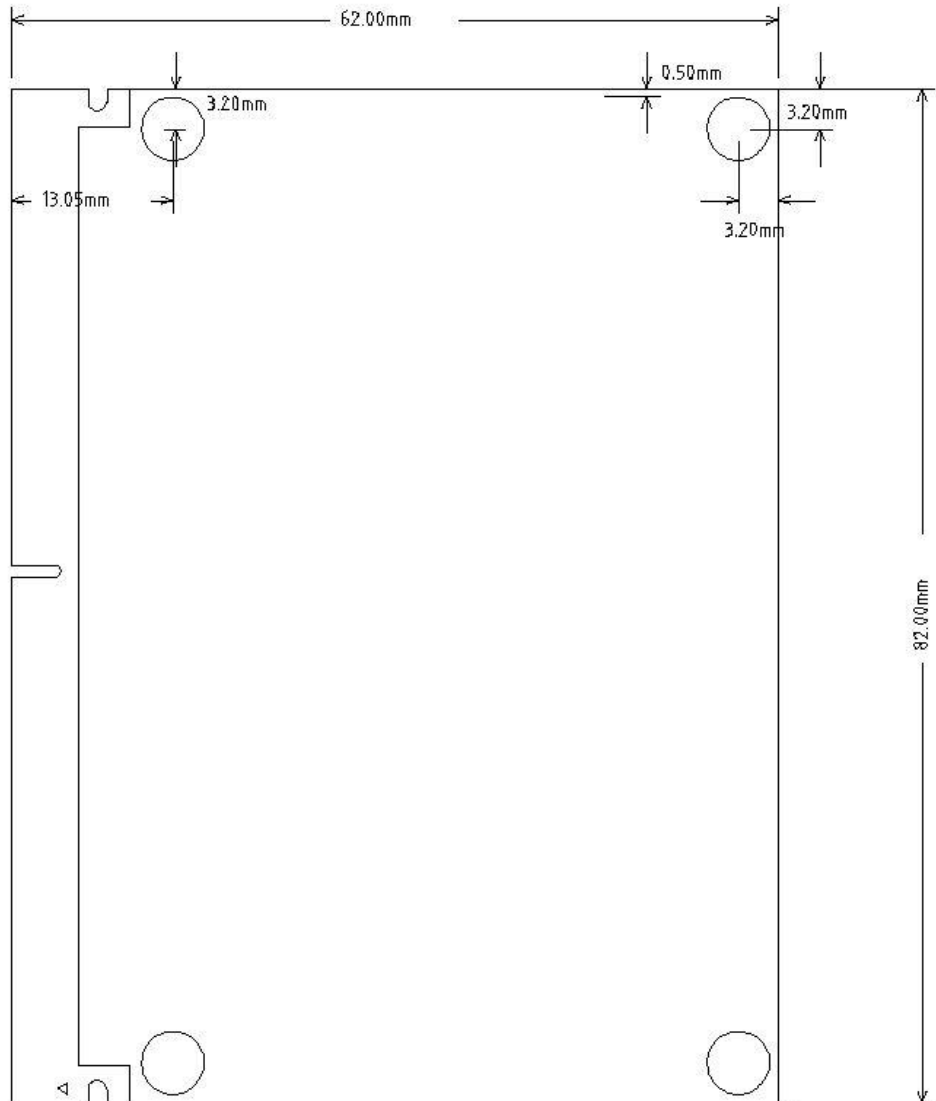

Figure 4-2 Mechanical Dimensions Modul

4.3.2 SBC-LS1046A

The following drawing shows the mechanical outline of the SBC-LS1046A assembly.



This drawing is not to scale.



For 3D data files please contact MicroSys.

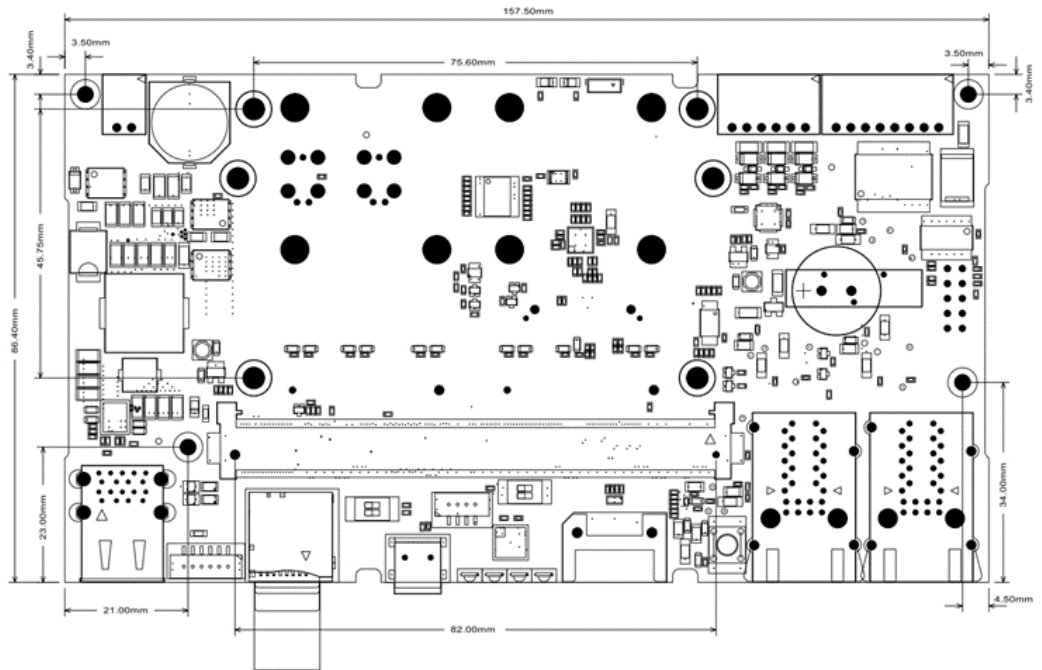

Figure 4-3 SBC-LS1046A Mechanical Dimensions

4.4 Connector Layout – Top

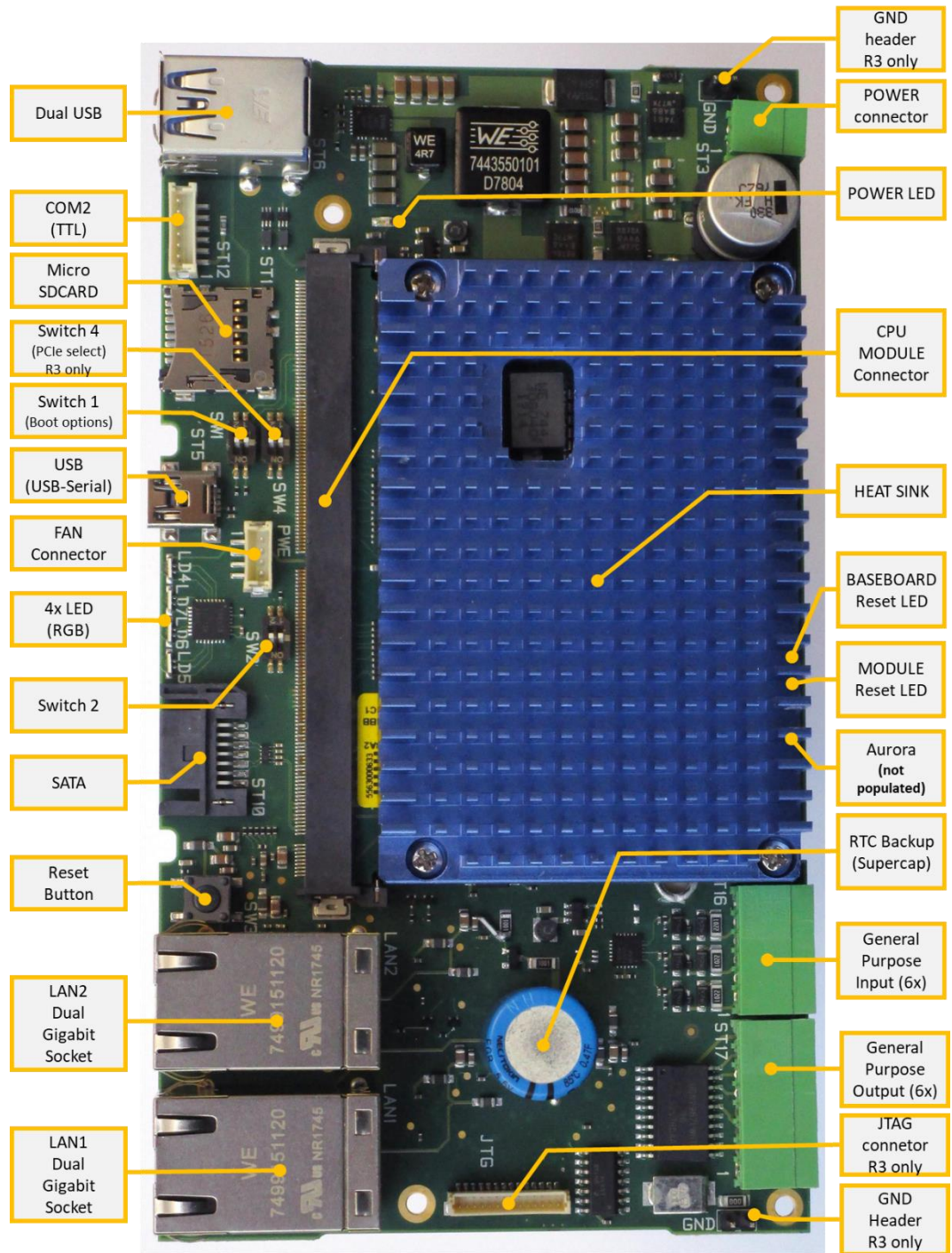

Figure 4-4 Top connectors

4.5 Connector Layout – Bottom

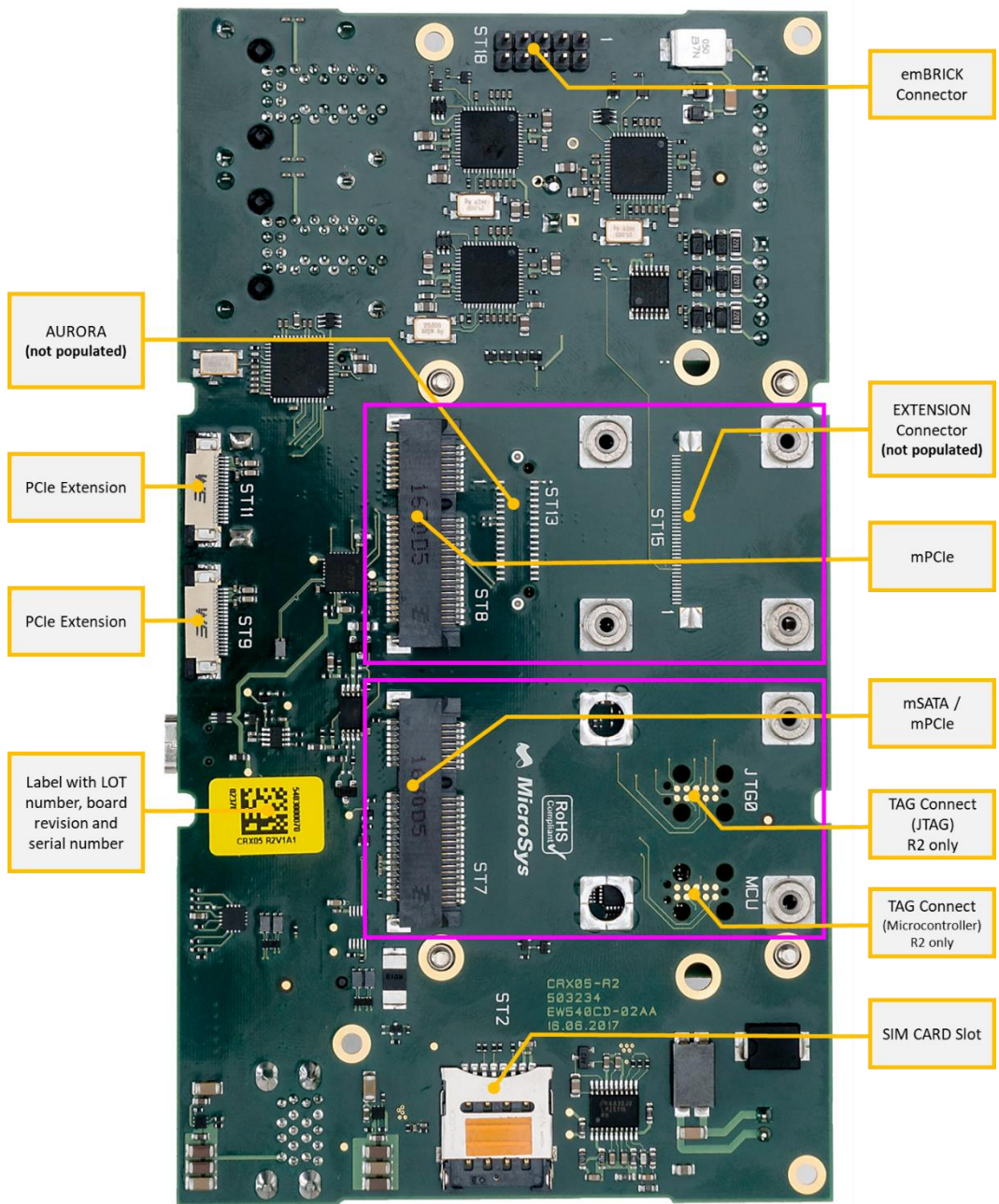

Figure 4-5 Bottom connectors

4.6 Power Supply

4.6.1 Input Supply Rating

The SBC-LS1046A system is run from a single DC power supply with the following ratings:

Maximum Input Voltage Operating Range:	9V - 30V DC
Nominal Input Supply Voltage:	12V DC
Typical Current Consumption (@12V / room temperature / U-boot prompt):	~0,70A



**ALWAYS use the correct type and polarity of the power supply!
DO NOT exceed the rated maximum values for the power supply! This may result in severe permanent damage to the unit, as well as possible serious injury.**

4.6.2 Input Power Connector

Part Reference	ST3
Manufacturer:	Würth Elektronik
Type:	691 382 010 002
Mates with:	691 381 000 002 (included in delivery)



Pin-out:

Pin	Name	Function
1	„+“	+VIN (= typ. 12V)
2	„-“	GND

Table 4-1 Pinout ST3

4.6.3 Power Supply Structure

- Input Power from ST3 connector is fed to the primary step-down converter.
- The primary step-down converter produces 5V DC / max. 8A peak from the input supply which supplies both the LS1046A module and peripheral devices on the carrierboard CRX05.

- The 5V DC are fed to a secondary step-down converter, which produces 3.3V DC / max. 4A peak.
- Two NCP1529 produce 1.8V and 1.5V from 3.3V, which are used for both PCIe and onboard devices.

The following diagram shows the Power Supply structure:

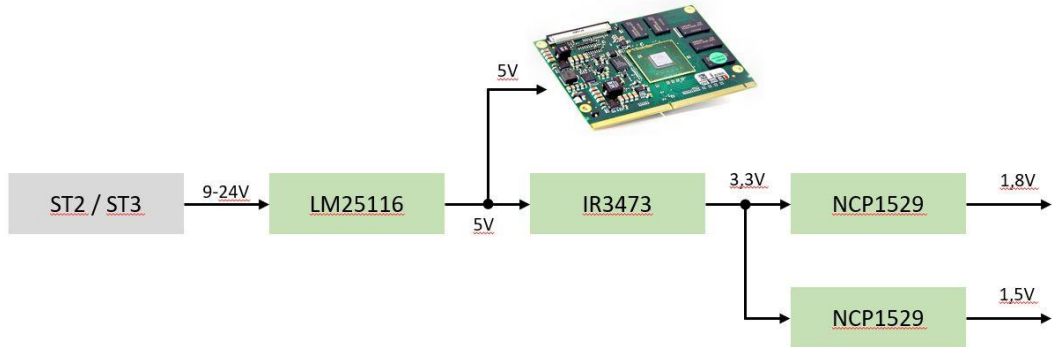

Figure 4-6 Power supply structure

4.6.4 RTC Backup Battery

The RTC on the module is supplied from a 470mF supercap that is loaded by the 5V power source on the carrier board.



Alternatively, there's another version of the carrier board available that has a backup battery holder for CR2032 batteries. Please contact MicroSys for more information.

Part Reference:	BAT1
Manufacturer:	Renata Batteries
Type:	VBH2032-1
Used with:	CR2032 batteries

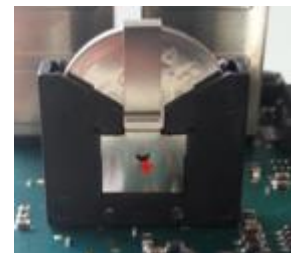

4.6.5 Current Measurement

For current measurements the carrierboard provides a 10mΩ shunt resistor in the 5V path supplying the CPU module.

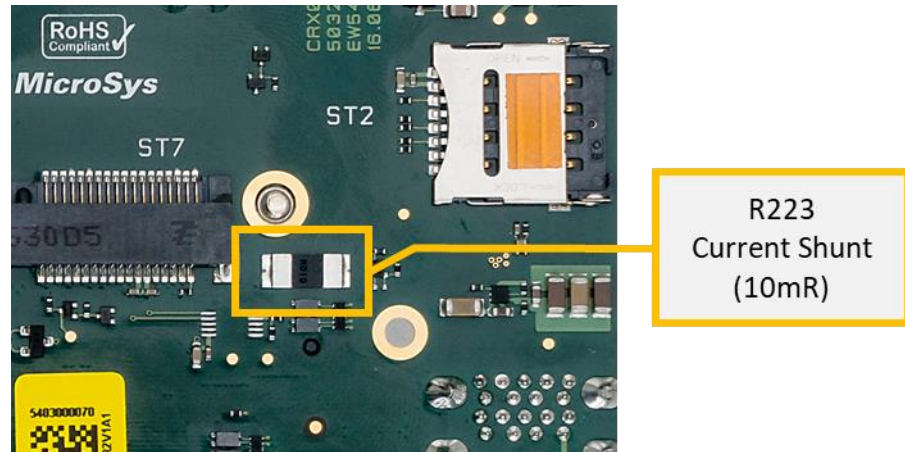

For automated measurements there's a carrierboard version available that already provides an I²C current sense amplifier.



NOTE

The current sense amplifier is not populated by default.

For more information please contact MicroSys.

4.6.6 Fuses

There are no fuses on the SBC-LS1046A.

5 System Core, Boot Configuration and On-Board Memory

5.1 Processor NXP LS1046A

The LS1046A Processor by NXP is a QorIQ Layerscape CPU with four CPU cores. It exposes a wide variety of external interfaces, which are explained in detail in the following chapters. The cores have a unified L2 Cache.

The four CPU cores run at a maximum clock speed of 1800 MHz, 1600 MHz, 1400 MHz or 1200 MHz respectively, depending on the ordered type. The CPU frequency can be clocked down if necessary.

5.2 JTAG Chain

The JTAG chain of the SBC-LS1046A includes the LS1046A processor only. The JTAG port is directly connected to the connector “JTGO”.

The JTAG connector footprint provides JTAG signals. For interfacing standard debugger pinouts an additional intermediate adapter is necessary.

Please see chapter 6.10 for a description of the JTAG connector.

5.3 Reset Structure

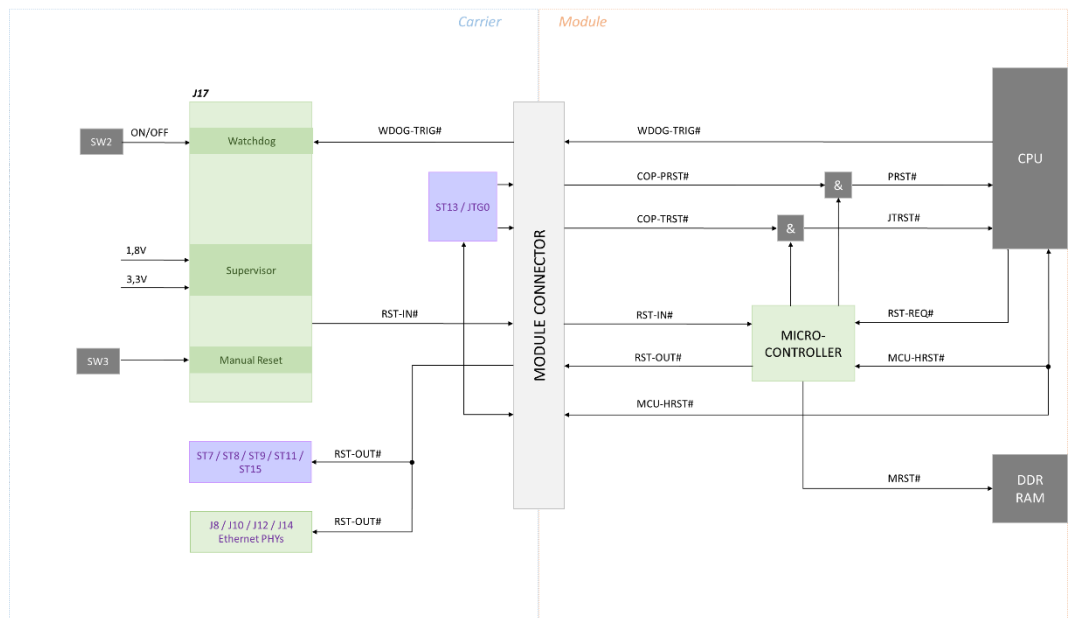

Figure 5-1 Reset Structure (carrier CRX05 Revision 2)

Pin Number on ST4	Signal Name	Signal Direction	Function
T136	RST-IN#	Input to the module	Active low module reset: while active the module is held in reset state
T135	RST-OUT#	Output from the module	Active low peripheral reset: while active peripheral devices shall be held in reset state
B118	WDOG-TRIG#	Output from the module	Watchdog service signal from the module which has to be triggered periodically. When the watchdog is active and the service stops the module will be reset.
B111	MCU-HRST#	Bi-directional	Please contact MicroSys
B110	COP-PRST#	Input to the module	Please contact MicroSys
B106	COP-TRST#	Input to the module	Please contact MicroSys

Table 5-1 Reset signal overview



NOTE

The default state for RST-IN# is active. Consequently, the module is always in a reset state when the RST-IN# signal is not actively driven high by the carrierboard.

The RST-IN# is an input to the module. It signals that the voltage supplies on the carrierboard are within their limits and no manual reset is triggered. When active (signal is low) the microcontroller unit on the module initiates the reset sequence in order to keep the CPU in a defined reset state. No further interaction from the carrierboard is necessary. In case the module reset is active, the module triggers the RST-OUT# signal which is intended to control the reset of peripheral devices on the carrierboard i.e. Ethernet PHYs, PCIe slots and devices.

The RST-IN# signal can be triggered by either a power fault situation, a manual reset button press (SW3) or a missing watchdog trigger signal WDOG-TRIG# from the CPU in case the watchdog has been manually enabled beforehand via SW2.

MCU-HRST#, COP-PRST# and COP-TRST# are for JTAG and debugging purposes only.



NOTE

The watchdog is off by default.

The watchdog is implemented on the carrier board.

The following voltages on the carrier board are monitored by a Maxim MAX6751KA29 chip:

Voltage	Monitoring	Voltage Limit
3,3V	Undervoltage	Typ. 2,925V [2,867V-2,984V]
1,8V	Undervoltage	Typ. 1,72V [1,69V-1,75V]

Table 5-2 Voltage monitoring limits (carrier)

5.4 Clock Distribution

The following diagram shows the clock distribution of the SBC-LS1046A system



IDT6V49205B		LS1046A	
Pin	Name	Name	Pin
23	PCIeT_LR0	SD1-REFCLK1	AA8
24	PCIeC_LR0	SD1-REFCLK1#	AB8
26	PCIeT_LR1	SD1-REFCLK2	AB18
25	PCIeC_LR1	SD1-REFCLK2#	AB19

		ST4		J6	
		Signal	Pin	Signal	Pin
36	PCIeT_LR4	SRD-CLK1+	T50	SRC	19
35	PCIeC_LR4	SRD-CLK1-	T51	SRC#	20

		ST7	
OUT0	2	PCIE-CLKD+	13
OUT0#	3	PCIE-CLKD-	11

		ST8	
OUT1	5	PCIE-CLKB+	13
OUT1#	6	PCIE-CLKB-	11

		ST11	
OUT2	12	PCIE-CLKC+	A13
OUT2#	11	PCIE-CLKC-	A14

		ST9	
OUT3	15	PCIE-CLKA+	7
OUT3#	14	PCIE-CLKA-	6

Table 5-3 Clock distribution

5.5 Boot Configuration

The SBC-LS1046A board offers three possible boot devices to choose from. The settings can be done via SW1 (see chapter 7 for details). SW1 configures two signals “BOOT-SEL1” and “BOOT-SEL2” which have a default high state (10k pullups are on the module) when no connection is made or SW1 is off. When the switch is on, the respective pin is grounded.

The BOOT-SELx pins are decoded to the following configuration (1= high, 0=low):

LS1046A		BOOT-SEL2 BOOT-SEL1 =		
Signal	Pin	SDHC =[10]	SPI =[11]	NAND =[01]
IFC_AD08	B9	0	0	1
IFC_AD09	A9	0	0	0
IFC_AD10	A10	1	1	0
IFC_AD11	B11	0	0	0
IFC_AD12	A11	0	0	0
IFC_AD13	B12	0	0	0
IFC_AD14	A12	0	1	1
IFC_AD15	A13	0	0	1
IFC_CLE	F16	0	1	1

Table 5-4 Hard wired boot signals

5.6 NAND Flash

The SBC-LS1046A system is equipped with 2GB of NAND Flash by default. Different sizes may be available on request/order. The following table shows the connections and signal levels for the NAND Flash.

I/O Range	NAND Flash			SBC-LS1046A		LS1046A		Description
	Pin	Name		Signal		Pin	Name	
1,8V	G5	LOCK						Lock
1,8V	C8	RY/BY	→	IFC-RB0#	→	C16	IFC_RB0#	ready/busy, 4,7K pullup
1,8V	D4	RE#	←	IFC-OE#	←	C18	IFC_OE#	read enable
1,8V	C6	CE#	←	IFC-CS0#	←	C17	IFC_CS0#	chip select
1,8V	D3,G4,H8, J6	VCC		+1.8V				
	C5,F7,K3, K8	GND		GND				
1,8V	D5	CLE	←	IFC-CLE	←	C19	IFC_CLE	command latch enable
1,8V	C4	ALE	←	IFC-AVD	←	A18	IFC_AVD	address latch enable
1,8V	C7	WE#	←	IFC-WE#	←	C15	IFC_WE0#	write enable
1,8V	C3	WP#	←	IFC-WP#	←	D19	IFC_WP0#	write protect
1,8V	H4	D0	↔	IFC-AD7	↔	B12	IFC_AD7	data line
1,8V	J4	D1	↔	IFC-AD6	↔	A11	IFC_AD6	data line
1,8V	K4	D2	↔	IFC-AD5	↔	B11	IFC_AD5	data line
1,8V	K5	D3	↔	IFC-AD4	↔	A10	IFC_AD4	data line
1,8V	K6	D4	↔	IFC-AD3	↔	A9	IFC_AD3	data line
1,8V	J7	D5	↔	IFC-AD2	↔	B9	IFC_AD2	data line
1,8V	K7	D6	↔	IFC-AD1	↔	A8	IFC_AD1	data line
1,8V	J8	D7	↔	IFC-AD0	↔	B8	IFC_AD0	data line
	G3	n.c.						Not connect
	G8	n.c.						Not connect

Table 5-5 NAND Flash pin assignments

5.7 QSPI Flash

The SBC-LS1046A system is equipped with 16MB of QSPI Flash on the LS1046A's QSPI port. Up to 64 MB are available on request/order.

The following table shows the internal connections:

I/O Range	QSPI Flash MT25QU128ABA8E12			LS1046A	
	Pin	Name		Pin	Name
LVTTL	C2	CS	←	D8	QSPI_A_CS0
LVTTL	B2	CLK	←	C9	QSPI_A_SCK
	B3	GND	←		
LVTTL	D3	D0	↔	D11	QSPI_A_DATA0
LVTTL	D2	D1	↔	C12	QSPI_A_DATA1
LVTTL	C4	D2	↔	D13	QSPI_A_DATA2
LVTTL	D4	D3	↔	C13	QSPI_A_DATA3
	B4	+1.8V			

Table 5-6 QSPI Flash pin assignment

5.8 I²C Bus

The SBC-LS1046A offers two independent I²C busses.

The following tables show the I²C addresses as 7 Bit addresses. The R/W bit is not displayed.

5.8.1 I2C-1

I²C Bus 1 (7-Bit address):

Address	Device	Function
0x32	RX-8803LC	RTC
0x00	TMP451AIDQF	General Call reset address
0x4C		Temperature sensor
0x50	BR24G128NUX-3	EEPROM (on module)
0x57 / (0x55) Selectable via SW2 (see 7.2)	BR24G128NUX-3	EEPROM (on carrier)
0x58	MAX7325ATG	Port Expander GP output address
0x68		Port Expander GP input address
0x60	TLC59116IRHBR	RGB LED Driver Slave Address
0x68		All Call Address (must be disabled!)
0x6B		Software Reset Address
0x69	IDT6V49205BNLGI	Clock Generator

Table 5-7 I²C1 bus map



I²C address 0x68 is existing twice on I2C-1 bus.

Therefore, the so-called “All Call I2C address” of the TLC59116IRHBR RGB LED driver has to be disabled before GP input pins of the MAX7325 port expander can be read correctly. This can be achieved by setting the default value 1 of Bit 0 in MODE1 register to 0.

The I²C Bus 1 has the following layout:

I/O Range: LVTTTL

Device	SCL (Signal Name)	Pin	SDA (Signal Name)	Pin
LS1046A	IIC1_SCL	N1	IIC1_SDA	M1
	↓		↑	
RX-8803LC	SCL	5	SDA	8
	↓		↑	
BR24G128NUX-3	SCL	6	SDA	5
	↓		↑	
TMP451AIDQF	SCK	8	SDA	7
	↓		↑	
IDT6V49205B	SCLK	46	SDATA	47
	↓		↑	
Module Connector	I2C1_SCL	B78	I2C1_SDA	B77
	↓		↑	
MAX7325	SCL	19	SDA	20
	↓		↑	
BR24G128NUX-3	SCL	6	SDA	5
	↓		↑	
TLC59116IRHBR	SCL	25	SDA	26

Table 5-8 I²C-1 pin assignment

5.8.2 I2C-2

I²C Bus 2 (7-Bit address):

Address	Device	Function
0x28	SC18IS602BIPW	I2C to SPI Bridge
0x70	TCA9544APWR	I ² C Multiplexer (for I ² C ports on PCIe slots)
0x73	MAX9611AUB (not populated by default)	Current Monitor for module consumption

Table 5-9 I²C2 bus map



I²C-2 is not available when SD-card boot mode is selected!

The following graphic shows the I²C multiplexer's channels:

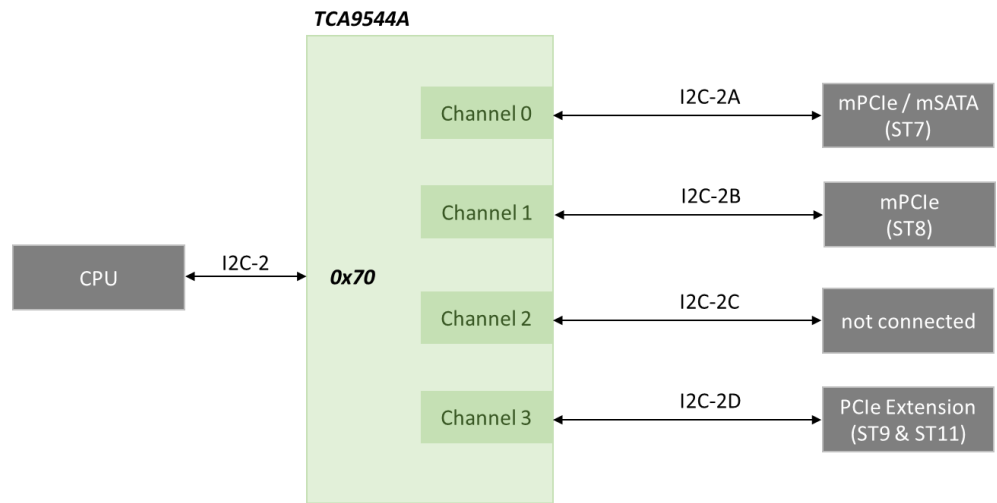

The I²C bus 2 has the following layout:

I/O Range: LVTTTL

Device	SCL (Signal Name)	Pin	SDA (Signal Name)	Pin
LS1046A	IIC2_SCL	K3	IIC2_SDA	L3
	↓		↕	
Module Connector	I2C2_SCL	B75	I2C2_SDA	B74
	↓		↕	
TCA9544APWR	SCK	7	SDA	8
	↓		↕	
SC18IS602BIPW	SCL	8	SDA	7
	↓		↕	
MAX9611AUB	SCL	6	SDA	7

Table 5-10 I²C-2 pin assignment

6 Peripherals

6.1 Connector References

Reference	Function	Populated?	Top / Bottom
ST1	Micro SD slot	✓	Top
ST2	Smart Card connector	✓	Bottom
ST3	Power connector	✓	Top
ST4	CPU Module Connector	✓	Top
ST5	USB to serial connector	✓	Top
ST6	Dual USB connector	✓	Top
ST7	mPCIe / mSATA slot	✓	Bottom
ST8	mPCIe slot	✓	Bottom
ST9	PCIe extension connector	✓	Bottom
ST10	SATA connector	✓	Top
ST11	PCIe extension connector	✓	Bottom
ST12	UART2 connector	✓	Top
ST13	Aurora connector 1	-	Bottom
ST14	Aurora connector 2	-	Bottom
ST15	Extension connector	-	Bottom
ST16	GPIN connector	✓	Top
ST17	GPOUT connector	✓	Top
ST18	emBRICK connector	✓	Bottom
PWE	Fan connector	✓	Top
LAN1	RJ45 connector	✓	Top
LAN2	RJ45 connector	✓	Top
MCU	Microcontroller	TAG connect	Bottom R2 only
JTG0	JTAG connector	TAG connect JST-BM14-SRSS	Bottom (R2) Top (R3)

Table 6-1 Connector reference overview

6.2 Module Connector

The carrierboard CRX05 provides a connector “ST4” which accepts compatible CPU modules from the MicroSys MPX2-family.

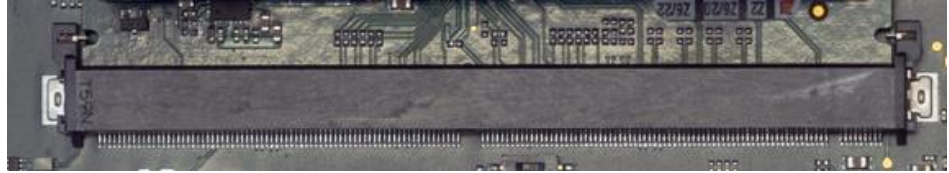

Manufacturer:	JAE
Type:	MM70-314-310-B1-1-R300
Used with:	MicroSys MPX2 module family

6.3 LAN Connections

The SBC-LS1046A system offers four independent Gigabit LAN connections. These three ports are distributed over two connectors named “LAN1” and “LAN2”. The connectors have integrated magnetics.

The following picture shows the front view of the two connectors as placed on the CRX05 baseboard. For further information on the LEDs please see chapter 8

Part Reference:	LAN1, LAN2
Manufacturer:	Würth Elektronik
Type:	749 915 1120
Mates with:	RJ45 patch cable, category depending on speed

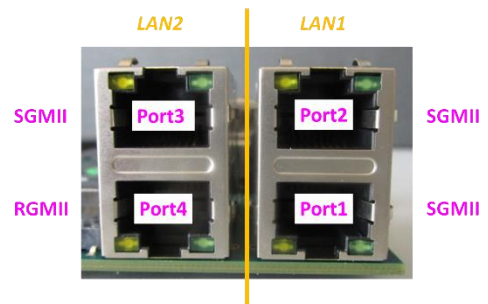

Port	LS1046A connection	Serdes Lane on ST4	RGMII on ST4	PHY address
1	„DTSEC9“	Lane1	---	0000
2	„DTSEC6“	Lane2	---	0001
3	„DTSEC5“	Lane3	---	0010
4	„DTSEC3“	---	RGMII1	0011

Table 6-2 LAN / DTSEC / SerDes / RGMII assignment

The LAN Sockets have a standard layout for GBit Ethernet, i.e. the pairs are 1-2, 3-6, 4-5 and 7-8.

Pin	Pair
1	D-A+
2	D-A-
3	D-B+
4	D-C+
5	D-C-
6	D-B-
7	D-D+
8	D-D-

Table 6-3 LAN Gigabit Ethernet connector pairs

6.3.1 Port 1

Port 1 is connected to a standard RJ-45 socket "LAN1". It uses the SerDes Lanes 1 provided by the LS1046A CPU configured as SGMII port. The SGMII lanes connect to a Marvell PHY 88E1512P which uses a copy of the reference voltage on pin T80 of the module connector ST4 as I/O voltage (1.8V).

88E1512P			ST4			LS1046A	
Pin	Name		Pin	Signal		Pin	Name
1	S_INP	←	T41	SRD-TX1+	←	AD6	SD1-TX0
2	S_INN	←	T42	SRD-TX1-	←	AE6	SD1-TX0#
4	S_OUTP	→	T38	SRD-RX1+	→	AG6	SD1-RX0
5	S_OUTN	→	T39	SRD-RX1-	→	AH6	SD1-RX0#

Table 6-4 SerDes 1 pin assignment

6.3.2 Port 2

Port 2 is connected to a standard RJ-45 socket "LAN1". It uses the SerDes Lanes 2 provided by the LS1046A CPU configured as SGMII port. The SGMII lanes connect to a Marvell PHY 88E1512P which uses a copy of the reference voltage on pin T80 of the module connector ST4 as I/O voltage (1.8V).

88E1512P			ST4			LS1046A	
Pin	Name		Pin	Signal		Pin	Name
1	S_INP	←	T35	SRD-TX2+	←	AD11	SD-TX3
2	S_INN	←	T36	SRD-TX2-	←	AE11	SD-TX3#
4	S_OUTP	→	T32	SRD-RX2+	→	AG11	SD-RX3
5	S_OUTN	→	T33	SRD-RX2-	→	AH11	SD-RX3#

Table 6-5 SerDes 2 pin assignment

6.3.3 Port 3

Port 3 is connected to a standard RJ-45 socket "LAN2". It uses the SerDes Lanes 3 provided by the LS1046A CPU configured as SGMII port. The SGMII lanes connect to a Marvell PHY 88E1512P which uses a copy of the reference voltage on pin T80 of the module connector ST4 as I/O voltage (1.8V).

88E1512P			ST4			LS1046A	
Pin	Name		Pin	Signal		Pin	Name
1	S_INP	←	T41	SRD-TX3+	←	AD10	SD1-TX1
2	S_INN	←	T42	SRD-TX3-	←	AE10	SD1-TX1#
4	S_OUTP	→	T38	SRD-RX3+	→	AG10	SD1-RX1
5	S_OUTN	→	T39	SRD-RX3-	→	AH10	SD1-RX1#

Table 6-6 SerDes 3 pin assignment

6.3.4 Port 4

Port 4 is connected to a standard RJ-45 socket "LAN2". It uses the Ethernet controller EC1 as RGMII port provided by the LS1046A CPU. The RGMII lanes connect to a Marvell PHY 88E1512P which uses a copy of the reference voltage on pin T80 of the module connector ST4 as I/O voltage (1.8V).

The following table shows the internal connections for Port 4.

I/O Range			88E1512P			ST4			LS1046A	
	Pull-up	Pull-down	Pin	Name		Pin	Signal		Pin	Name
1.8V			46	RX_CLK	→	T86	MII1-RXCK	→	W1	MII_RX_CLK
1.8V			43	RX_CTRL	→	T95	MII1-RXDV	→	AB1	MII_RX_DV
1.8V			44	RXD0	→	T88	MII1-RXD0	→	AA2	MII_RXD0
1.8V		4k7	45	RXD1	→	T89	MII1-RXD1	→	AA1	MII_RXD1
1.8V			47	RXD2	→	T91	MII1-RXD2	→	Y1	MII_RXD2
1.8V			48	RXD3	→	T92	MII1-RXD3	→	W2	MII_RXD3
1.8V			53	TX_CLK	←	T94	MII1-TXCK	←	W4	MII_TX_CLK
1.8V			50	TXD0	←	T97	MII1-TXD0	←	AB3	MII_TXD0
1.8V			51	TXD1	←	T98	MII1-TXD1	←	AA3	MII_TXD1
1.8V			54	TXD2	←	T100	MII1-TXD2	←	Y4	MII_TXD2
1.8V			55	TXD3	←	T101	MII1-TXD3	←	Y3	MII_TXD3
1.8V		4k7	56	TX_CTRL	←	T103	MII1-TXEN	←	AB4	MII_TXEN
1.8V	5k0		8	MDIO	↔	B87	MII1-MDIO	↔	AF2	EMI1_MDIO
1.8V	10k0		7	MDC	←	B86	MII1-MDC	←	AG2	EMI1_MDC
1.8V			9	CLK125	→	T83	MII1-CRS	→	AC3	EC1_GTX_CLK125

Table 6-7 Port4 pin assignment

6.4 PCIe Connections

The SBC-LS1046A offers three x1 lanes on the following connectors.

Serdes	ST7 (Mini-PCle / mSATA Slot)	ST8 (Mini PCIe Slot)	ST9 (PCIe Extension Connector)	ST11 (PCIe Extension Connector)
Lane 0			✓	
Lane 4		✓		
Lane 5				✓
Lane 7	✓ (mSATA)			

Table 6-8 PCIe SerDes assignment

Basically, the carrierboard offers four x1 lanes on different connectors which may be available in combination with other MPX2 modules.

6.4.1 Mini-PCle Slot

There are two mini PCIe slot on the carrierboard. The first one can hold mPCIe cards only, mSATA is not supported.

Part Reference:	ST8
Manufacturer:	Tyco
Type:	2041119-1
Used with:	Half size mini PCIe cards are preferred



Broaching nuts for both half and full size cards are placed on the carrier board. When full size cards are used care has to be taken to choose cards that do not have parts on the bottom side accidentally shorting signals.

MicroSys recommends to use half size cards with this slot only!

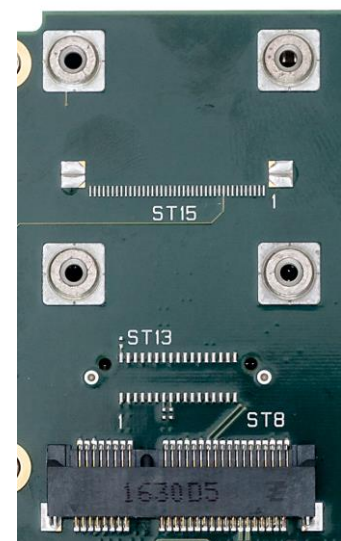

Pin:			Pin:
1	WAKE#	+3.3Vaux	2
3	COEX1	GND	4
5	COEX2	+1.5V	6
7	CLKREQ#	UIM-PWR	8
9	GND	UIM-DAT	10
11	REFCLK-	UIM-CLK	12
13	REFCLK+	UIM-RST	14
15	GND	UIM-VPP	16
MECHANICAL KEY			
17	Reserved	GND	18
19	Reserved	WDIS#	20
21	GND	PERST#	22
23	PER0-	+3.3Vaux	24
25	PER0+	GND	26
27	GND	+1.5V	28
29	GND	SMB-CLK	30
31	PET0-	SMB-DAT	32
33	PET0+	GND	34
35	GND	USB-D-	36
37	GND	USB-D+	38
39	+3.3Vaux	GND	40
41	+3.3Vaux	LED-WWAN#	42
43	GND	LED_WLAN#	44
45	Reserved	LED_WPAN#	46
47	Reserved	+1.5V	48
49	Reserved	GND	50
51	Reserved	+3.3Vaux	52

Table 6-9 mPCIe Slot pinout

The following table shows the internal connections:

ST8			ST4			LS1046A	
Pin	Name		Pin	Signal		Pin	Name
33	PET4+	←	T23	SRD-TX4+	←	AD15	SD2-TX0
31	PET4-	←	T24	SRD-TX4-	←	AE15	SD2-TX0#
25	PER4+	→	T20	SRD-RX4+	→	AG15	SD2-RX0
23	PER4-	→	T21	SRD-RX4-	→	AH15	SD2-RX0#

Table 6-10 mPCIe Slot SerDes 4 assignment

6.4.2 Mini-PCIe Slot / mSATA Slot

Basically, the second slot can hold both mSATA cards and mPCIe cards.

Depending on the software configuration (SerDes configuration) either mSATA or mPCIe cards can be used.

Part Reference:	ST7
Manufacturer:	Tyco
Type:	2041119-1
Used with:	Full size or half size mini PCIe or mSATA cards



Four holes for broaching nuts are designed to allow for half and full size cards to be used with this slot.

The broaching nuts for half size cards are not populated as standard to allow cards without height restrictions.

Revision 3 has NO connector JTG0 and MCU in this area!



Pin:			Pin:
1	WAKE#	+3.3Vaux	2
3	COEX1	GND	4
5	COEX2	+1.5V	6
7	CLKREQ#	UIM-PWR	8
9	GND	UIM-DAT	10
11	REFCLK-	UIM-CLK	12
13	REFCLK+	UIM-RST	14
15	GND	UIM-VPP	16
MECHANICAL KEY			
17	Reserved	GND	18
19	Reserved	WDIS#	20
21	GND	PERST#	22
23	PER0+	+3.3Vaux	24
25	PER0-	GND	26
27	GND	+1.5V	28
29	GND	SMB-CLK	30
31	PET0-	SMB-DAT	32
33	PET0+	GND	34
35	GND	USB-D-	36
37	GND	USB-D+	38
39	+3.3Vaux	GND	40
41	+3.3Vaux	LED-WWAN#	42
43	GND	LED_WLAN#	44
45	Reserved	LED_WPAN#	46
47	Reserved	+1.5V	48
49	Reserved	GND	50
51	Reserved	+3.3Vaux	52

Table 6-11 mPCIe / mSATA Slot pinout

The following table shows the internal connections:

ST7			ST4			LS1046A	
Pin	Name		Pin	Signal		Pin	Name
33	PET0+	←	T5	SRD-TX7+	←	AD19	SD2_TX3_P
31	PET0-	←	T6	SRD-TX7-	←	AE19	SD2_TX3_N
23	PER0-	→	T2	SRD-RX7+	→	AG19	SD2_RX3_P
25	PER0+	→	T3	SRD-RX7-	→	AH19	SD2_RX3_N

Table 6-12 mPCIe Slot SerDes 7 assignment

6.4.3 PCIe Extension Connector 1

The PCIe Extension Connectors “ST9” and “ST11” provide basic PCIe signals. They have identical pinouts providing power, data, clock, reset and I²C signals.

Depending on the module and software configuration the data signals can also be used for other interfaces according to the SerDes configuration of the respective module.

The extension connectors interface the CRX05 carrier board with any specially developed adapter. No standard pinout is used.

Part Reference:	ST9
Manufacturer:	Würth Elektronik
Type:	687 118 140 22
Mates with:	FFC cable, 18pins, pitch 0.5mm



The I²C port is accessible via I²C Bus 2 and the I²C multiplexer TCA9544A (address 0x70). See chapter 5.8.2 for more information.

NOTE *Devices connected to ST9 and ST11 share channel 3.*

Pin:	
1	+3.3V
2	+3.3V
3	+3.3V
4	+1.5V
5	GND
6	REFCLK-
7	REFCLK+
8	GND
9	PER0-
10	PER0+
11	GND
12	PET0-
13	PET0+
14	GND
15	I2C2D-SCL
16	I2C2D-SDA
17	GND
18	PERST#

Table 6-13 PCIe Extension connector pinout (ST9)

The following table shows the internal connections:

ST9			ST4			LS1046A	
Pin	Name		Pin	Signal		Pin	Name
13	PET0+	←	T47	SRD-TX0+	←	AD18	SD2-TX2
12	PET0-	←	T48	SRD-TX0-	←	AE18	SD2-TX2#
10	PER0+	→	T44	SRD-RX0+	→	AG18	SD2-RX2
9	PER0-	→	T45	SRD-RX0-	→	AH18	SD2-RX2#

Table 6-14 PCIe Edge Card connector SerDes 0 assignment

6.4.4 PCIe Extension Connector 2

Part Reference:	ST11
Manufacturer:	Würth Elektronik
Type:	687 118 140 22
Mates with:	FFC cable, 18pins, pitch 0.5mm



The I2C port is accessible via I2C Bus 2 and the I2C multiplexer TCA9544A (address 0x70). See chapter 5.8.2 for more information.

NOTE

Devices connected to ST9 and ST11 share channel 3.

Pin:	
1	+3.3V
2	+3.3V
3	+3.3V
4	+1.5V
5	GND
6	REFCLK-
7	REFCLK+
8	GND
9	PER0-
10	PER0+
11	GND
12	PET0-
13	PET0+
14	GND
15	I2C2D-SCL
16	I2C2D-SDA
17	GND
18	PERST#

Table 6-15 PCIe Extension connector pinout (ST11)

The following table shows the internal connections:

ST11			ST4			LS1046A	
Pin	Name		Pin	Signal		Pin	Name
13	PET0+	←	T17	SRD-TX5+	←	AD16	SD2-TX1_P
12	PET0-	←	T18	SRD-TX5-	←	AE16	SD2-TX1_N
10	PER0+	→	T14	SRD-RX5+	→	AG16	SD2-RX1_P
9	PER0-	→	T15	SRD-RX5-	→	AH16	SD2-RX1_N

Table 6-16 PCIe Edge Card connector SerDes 5 assignment

6.4.5 PCIe with external clock

To run board with external PCIe clock board has to be modified on assembly level. Please contact MicroSys if required.

6.5 SATA



The SATA port is not available with the SBC-LS1046A system.

NOTE

Part Reference:	ST10
Manufacturer:	3M
Type:	5607-4200-SH
Used with:	SATA cable (7pin)



The following table shows the internal connections:

ST10			ST4			LS1046A	
Pin	Name		Pin	Signal		Pin	Name
1	GND						
2	A+	←	T11	SRD-TX6+	←	AD19	SD2-TX3
3	A-	←	T12	SRD-TX6-	←	AE19	SD2-TX3#
4	GND						
5	B-	→	T9	SRD-RX6-	→	AH19	SD2-RX3#
6	B+	→	T8	SRD-RX6+	→	AG19	SD2-RX3
7	GND						

Table 6-17 SATA connector pin assignment

6.6 microSD Card Slot

The SBC-LS1046A system offers a microSD Card slot.

The microSD card can also be configured as a boot device.

Part Reference:	ST1
Manufacturer:	Yamaichi
Type:	PJS-008-2130-0
Used with:	microSD cards

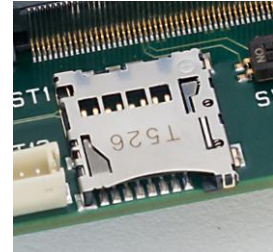

The following table shows the connections of the microSD card slot:

I/O Range	ST1			ST4			LS1046A	
	Pin	Name		Pin	Signal		Pin	Name
LVTTTL	1	DAT2	↔	B96	SDC-D2	↔	R1	SDHC_DAT2
LVTTTL	2	CD/DAT3	↔	B95	SDC-D3	↔	T1	SDHC_DAT3
LVTTTL	3	CMD	↔	B99	SDC-CMD	↔	P2	SDHC_CMD
	4	Vdd						
LVTTTL	5	CLK	←	B100	SDC-CLK	←	P3	SDHC_CLK
	6	Vss						
LVTTTL	7	DAT0	↔	B98	SDC-D0	↔	P1	SDHC_DAT0
LVTTTL	8	DAT1	↔	B97	SDC-D1	↔	R2	SDHC_DAT1
LVTTTL	9	SW1	→	B90	SDC-CD#			
LVTTTL	10	SW2	→	B89	SDC-WP			

Table 6-18 microSD card slot pin assignment



The microSD card slot uses a copy of the reference voltage on pin B81 of the module connector ST4 as I/O voltage (3.3V).

This voltage is generated on the carrierboard.

6.7 USB

The SBC-LS1046A system features a stacked USB connector for two ports.

Both USB host ports support USB super speed mode

Part Reference:	ST6
Manufacturer:	Würth Elektronik
Type:	692 141 030 100
Mates with:	USB Type A cables

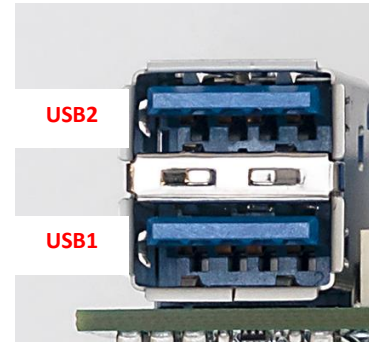

6.7.1 USB1

The following table shows the internal connections:

ST6 (Bottom)			ST4			LS1046A	
Pin	Signal		Pin	Signal		Pin	Name
1	Vbus+	→	B133	USB1-VBUS	→	E7	USB1_VBUS
2	D-	↔	T131	USB1-D-	↔	E6	USB1_D_M
3	D+	↔	T130	USB1-D+	↔	F6	USB1_D_P
4	GND						
5	SSRX-	→	T118	USB1-SSRX+	→	E3	USB1_RX_P
6	SSRX+	→	T119	USB1-SSRX-	→	E4	USB1_RX_M
7	GND						
8	SSTX-	←	T122	USB1-SSTX-	←	F2	USB1_TX_M
9	SSTX+	←	T121	USB1-SSTX+	←	F1	USB1_TX_P
J4							
Pin	Signal						
4	ENABLE	←	B132	USB1-EN	←	H6	USB1_DRVVBUS
3	FAULT#	→	B131	USB1-OC	→	G6	USB1_PWRFAULT
		→	B130	USB1-UID	→	F5	USB1_ID

Table 6-19 USB Host-Only Port 1 pin assignment

USB port 1 can be individually enabled and has a separate overcurrent signal.



NOTE

USB1_PWRFAULT is a high-active signal. A logic high level signals the port is in an overcurrent situation

6.7.2 USB2

The following table shows the internal connections:

ST6 (Top)			ST4			LS1046A	
Pin	Signal		Pin	Signal		Pin	Name
1	Vbus+	→	B128	USB2-VBUS	→	C7	USB2_VBUS
2	D-	↔	T128	USB2-D-	↔	C6	USB2_D_M
3	D+	↔	T127	USB2-D+	↔	D6	USB2_D_P
4	GND						
5	SSRX-	→	T112	USB2-SSRX+	→	C3	USB2_RX_P
6	SSRX+	→	T113	USB2-SSRX-	→	C4	USB2_RX_M
7	GND						
8	SSTX-	←	T116	USB2-SSTX-	←	D2	USB2_TX_M
9	SSTX+	←	T115	USB2-SSTX+	←	D1	USB2_TX_P
J5							
Pin	Signal		Pin	Signal		Pin	Name
4	ENABLE	←	B127	USB2-EN	←	L4	USB2_DRVVBUS
3	FAULT#	→	B126	USB2-OC	→	M4	USB2_PWRFAULT
		→	B125	USB2-UID	→	D5	USB2_ID

Table 6-20 USB Host-Only Port 2 pin assignment

USB port 2 can be individually enabled and has a separate overcurrent signal.



USB2_PWRFAULT is a high-active signal. A logic high level signals the port is in an overcurrent situation

6.7.3 USB3

USB port 3 is not a native USB port of the CPU but converted from UART1 by means of a FT232RQ chip.

USB3 is available on an USB mini connector type B.

The port is used as the debug port of the LS1046A.

Part Reference:	ST5
Manufacturer:	Würth Elektronik
Type:	651 005 161 21
Used with:	Mini USB type B cables

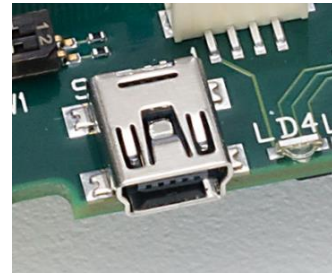

The following table shows the internal connections:

ST5		ST4		LS1046A		
Pin	Signal	Pin	Signal	Pin	Name	
1	Vbus+	B37	UART1-RXD	→	H2	UART1_SIN
2	D-	B38	UART1-TXD	←	H1	UART1_SOUT
3	D+	B39	UART1-CTS#	→	J1	UART1_CTS#
4	ID	B40	UART1-RTS#	←	J2	UART1_RTS#
5	GND					

Table 6-21 USB Host-Only Port 3 pin assignment

6.8 UART

The SBC-LS1046A system is provided with one serial port (UART).

UART1 is converted to USB. See chapter 6.7.3 for details.

UART2 is available on the following extension connector including hardware handshaking with RTS/CTS. The I/O range is LVTTTL.



For RS232 or RS485 additional transceivers are necessary. They are not implemented on the SBC-LS1046A system.

Part Reference:	ST12
Manufacturer:	Würth Elektronik
Type:	648 106 131 822
Mates with:	648 006 113 322

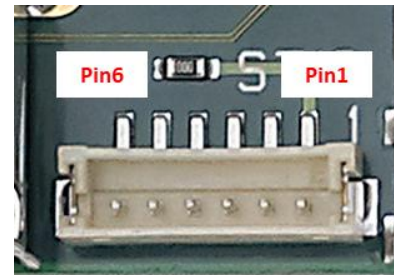

ST12			ST4			LS1046A	
Pin	Signal		Pin	Signal		Pin	Name
1	+3.3V						
2	UART2-RXD	→	B32	UART2-RXD	→	K1	UART2_SIN
3	UART2-TXD	←	B33	UART2-TXD	←	L2	UART2_SOUT
4	UART2-RTS#	←	B35	UART2-RTS#	←	L1	UART2_RTS#
5	UART2-CTS#	→	B34	UART2-CTS#	→	M2	UART2_CTS#
6	GND						

Table 6-22 UART2 pin assignment

6.9 MCU Connector

The connector "MCU" is for production test R2 only. Not available on CRX05R3.

Part Reference:	MCU
Manufacturer:	Tag-Connect
Type:	TC2050-IDC-FP

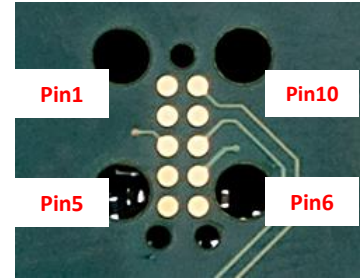

MCU	
Pin	Signal
1	Please contact MicroSys
2	
3	
4	
5	
6	
7	
8	
9	
10	

Table 6-23 MCU Connector Pinout

6.10 JTAG Connector

6.10.1 JTAG on Revision R3

The JTAG signals are available on JST-BM14B-SRSS-TB connector.

Part Reference:	JTG0
Manufacturer:	JST
Type:	BM14B-SrSS-TB



JTG0			ST4			LS1046A	
Pin	Signal		Pin	Signal		Pin	Signal
1	JTDO	←	B104	JTDO	←	E20	TDO
2	GND						
3	JTDI	→	B103	JTDI	→	G17	TDI
4	TRST#	→	B106	TRST#	→	E19	TRST#
5	+1,8V						
6	-						
7	JTCK	→	B105	JTCK	→	E18	TCK
8	HRST#	↔	B111	HRST#	↔	F8	HRESET#
9	JTMS	→	B102	JTMS	→	G18	TMS
10	GND						
11	PRST#	→	B110	PRST#	→	F9	PORESET#
12	GND						
13	MCU-UART-RDD	→	B114	MCU-UART-RDD	→	46	J11 MK02FN64VLH10
14	MCU-UART-TXD	←	B113	MCU-UART-TXD	←	49	J11 MK02FN64VLH10

Table 6-24 JTAG Connector Pinout R3

6.10.2 JTAG on Revision R2

The JTAG signals are available on a TAG connect footprint.

Part Reference:	JTG0
Manufacturer:	Tag-Connect
Type:	TC2050-IDC-FP

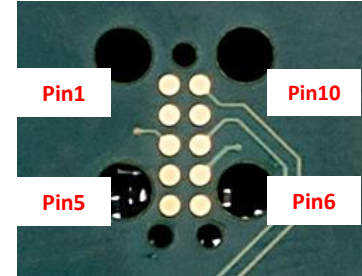

JTG0			ST4			LS1046A	
Pin	Signal		Pin	Signal		Pin	Signal
1	JTMS	→	B102	JTMS	→	G18	TMS
2	HRST#	↔	B111	HRST#	↔	F8	HRESET#
3	+1,8V						
4	TRST#	→	B106	TRST#	→	E19	TRST#
5	JTDO	←	B104	JTDO	←	E20	TDO
6	JTCK	→	B105	JTCK	→	E18	TCK
7	GND						
8	PRST#	→	B110	PRST#	→	F9	PORESET#
9	JTDI	→	B103	JTDI	→	G17	TDI
10	-						

Table 6-25 JTAG Connector Pinout R2

6.11 Aurora Connectors (optional)



The Aurora interface is not available with the LS1046A processor.

Part Reference:	ST13
Manufacturer:	Samtec
Type:	ASP-137973-01

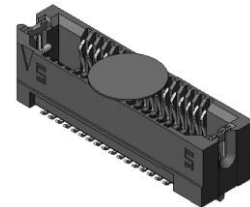

Pin:			Pin:
1	TX0+	VREF (1,8V)	2
3	TX0-	TCK	4
5	GND	TMS	6
7	TX1+	TDI	8
9	TX1-	TDO	10
11	GND	TRST#	12
13	TX2+	HALT#	14
15	TX2-	EVTI#	16
17	GND	EVTO#	18
19	TX3+	GEN_IO3	20
21	TX3-	RST#	22
23	GND	GND	24
25	TX4+	CLK+	26
27	TX4-	CLK-	28
29	GND	GND	30
31	TX5+	RDY#	32
33	TX5-	HRST#	34

Table 6-26 Aurora Connector Pinout

The module standard connector pinout (ST4) does not provide all signals which are necessary for the Aurora interface. Additional signals are available on the following connector "ST14". For more information please contact MicroSys.

Part Reference:	ST14
Manufacturer:	JST
Type:	SM06B-XSRS-ETB
Mates with:	06XSR-36S



Pin	Signal
1	HALT#
2	EVTI#
3	EVTO#
4	-
5	-
6	-

Table 6-27 Aurora Connector (ST14) Pinout

6.12 General Purpose Inputs / Outputs

The functional scope of the carrierboard has been extended by GPIOs which support a maximum of 24V at the input. The maximum output level depends on the input voltage which is limited to 24V. For lower input voltages an external voltage up to 24V can alternatively be supplied. In that case a hardware modification is necessary.

Inputs and outputs are controlled by a MAX7325ATG I²C GPIO Expander. The output pins are level shifted to either the input voltage or to the level of an externally supplied voltage. The output driver can be separately enabled and disabled. Additionally, a fault pin exists that signals a chip thermal shutdown or an overcurrent condition on any channel.

MAX7325ATG	Description
P6 (Pin7)	FAULT input: Logic low signals fault event
O14 (Pin16)	A logic high enables the GPOUT driver

GPINs:

Part Reference:	ST16
Manufacturer:	Würth Elektronik
Type:	691 382 010 006
Mates with:	691 381 000 006



Pin:	Description	MAX7325ATG
1	IN0	P0 (Pin1)
2	IN1	P1 (Pin2)
3	IN2	P2 (Pin3)
4	IN3	P3 (Pin4)
5	IN4	P4 (Pin5)
6	IN5	P5 (Pin6)

Table 6-28 GPIN connector pinout (ST16)

GPOUTs:

Part Reference:	ST17
Manufacturer:	Würth Elektronik
Type:	691 382 010 008
Mates with:	691 381 000 008



Pin:	Description		MAX7325ATG
1	+VIN / +VEXT		-
2	OUT6	Maximum output current on all ports together: 350mA	O13 (Pin15)
3	OUT5		O12 (Pin14)
4	OUT4		O11 (Pin13)
5	OUT3		O10 (Pin12)
6	OUT2		O9 (Pin11)
7	OUT1		O8 (Pin10)
8	GND		-

Table 6-29 GPOUT connector pinout (ST17)

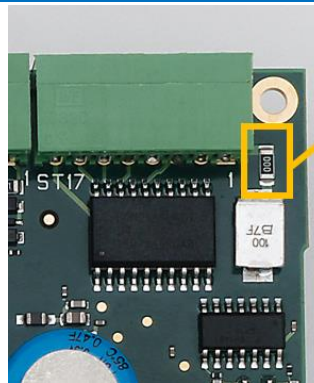

Remove R154 and supply GPOUTs with external voltage on PIN1

Pin 1 of connector ST17 is connected to the carrierboard input voltage via R154. In order to supply the GPOUT section with input voltages different from the input voltage R154 has to be removed. V_EXT on pin1 supports input voltages from 5V to 24V.

6.13 Fan Connector

The SBC-LS1046A provides a fan connector marked with „PWE“.

In case a fan is necessary MicroSys recommends using a 5V rated fan.

Part Reference:	PWE
Manufacturer:	Würth Elektronik
Type:	679 304 124 022
Mates with:	648 004 113 322

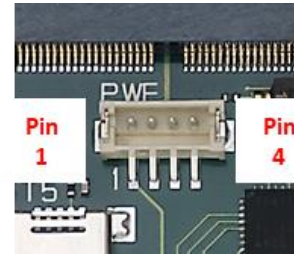

Pin:	Description
1	+5V
2	GND
3	GND
4	+VIN

Table 6-30 FAN connector pinout (PWE)

6.14 Smart Card Connector



THE SMART CARD INTERFACE IS NOT CONNECTED TO THE LS1046A CPU on CRX05-R2

Part Reference:	ST2
Manufacturer:	Würth Elektronik
Type:	693 022 010 811
Mates with:	t.b.d.

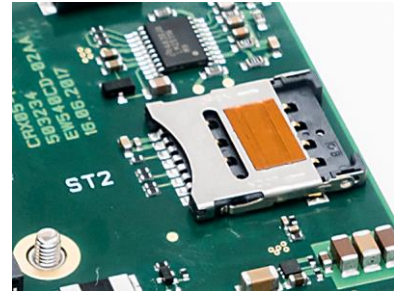

Connection von CRX05-R3:

ST2			ST4			LS1046A	
Pin	Signal Name		Pin	Description		Pin	Signal Name
1	+3,3V		-				
2	RST	←	B121	10k PU	←	C20	GPIO2_12
3	CLK	←	B122	10k PU	←	D20	GPIO2_11
4	-		-				
5	GND		-				
6	-		-				
7	I/O	↔	B123	10k PU	↔	A19	GPIO2_10
8	-		-				

Table 6-31 Smart Card connector pinout (ST2)

6.15 emBRICK Connector



THE emBRICK INTERFACE IS CURRENTLY NOT SUPPORTED

NOTE

Part Reference:	ST18
Manufacturer:	Würth Elektronik
Type:	613 005 211 21
Mates with:	Standard 2.54mm dual row socket

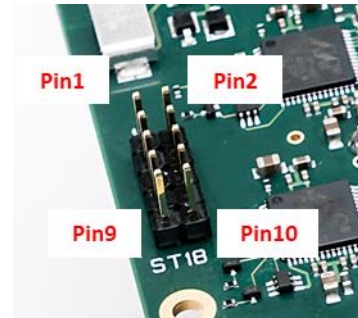

Pin	Signal Name	Connection
1	SEL_OUT	MAX7325ATG O15 (Pin17)
2	MOSI#	SC18IS602BIPW MOSI (Pin6)
3	MISO#	SC18IS602BIPW MISO (Pin5)
4	CLK#	SC18IS602BIPW SPICLK (Pin11)
5	+3,3V	
6	GND	
7	GND	
8	GND	
9	+VIN	
10	+VIN	

Table 6-32 emBRICK connector pinout (ST18)

7 Switches, Buttons and Jumpers

7.1 Boot Device Switch

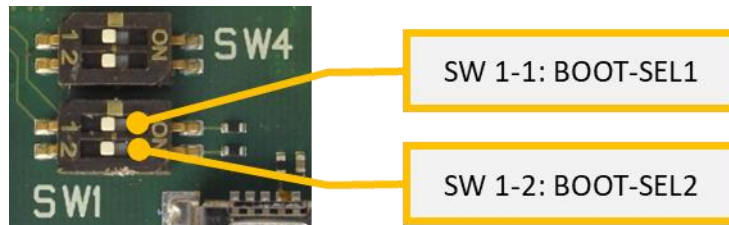

Figure 7-1 Boot Device Switch

The boot device can be selected by the switch “SW1”.

The boot device switches implement a maximum of four possible boot devices. The following boot devices are supported by the LS1046A:

Setting	SW 1-1	SW 1-2	Boot device	Features	Boot location
	OFF	OFF	SPI Flash		module
	OFF	ON	NAND Flash		module
	ON	OFF	SD/MMC	SD/MMC Bus width: 8 bit SPI-CS0# [PIN-B70] is <u>NOT</u> accessible	carrier board
	ON	ON	SD/MMC	SD/MMC Bus width: 4 bit SPI-CS0# [PIN-B70] is <u>NOT</u> accessible	carrier board

Table 7-1 Boot device settings



NOTE

SW1 inverts the logic levels of the BOOT-SELx pins. By setting the switch to ON the corresponding pin is actually pulled low (grounded).

The following table shows the internal connections of the BOOT-SEL pins:

SW1			ST4			Microcontroller	
Switch	Signal		Pin	Signal		Pin	Name
1-1	BOOT-SEL1	→	T134	BOOT-SEL1	→	61	PTD4
1-2	BOOT-SEL2	→	T133	BOOT-SEL2	→	62	PTD5

Table 7-2 BOOT-SELx pin assignment

7.2 Board Configuration Switch

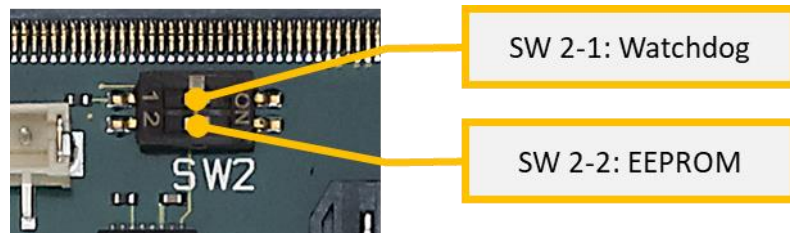

Figure 7-2 Board Configuration Switch

The board configuration switch influences the behavior of the watchdog and the I²C address of the EEPROM on I²C Bus1:

Setting	SW 2-1	SW 2-2	Description
	OFF	-	Watchdog disabled
	ON	-	Watchdog active
	-	OFF	EEPROM J25: address 0x57
	-	ON	EEPROM J25: address 0x55

Table 7-3 Configuration switch settings

7.3 PCIe selection: root complex / endpoint

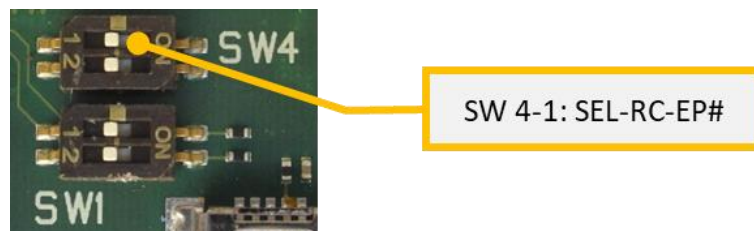

Figure 7-3 PCIe selection Switch

The PCIe configuration switch influences the behavior of root complex or endpoint.

Setting	SW 4-1	SW 4-2	Description
	OFF	-	PCIe = root complex
	ON	-	PCIe = endpoint
	-	OFF	Not used
	-	ON	Not used

Table 7-4 PCIe Configuration switch settings

7.4 Reset Button

Pressing the reset switch “SW3” triggers a Hard Reset.

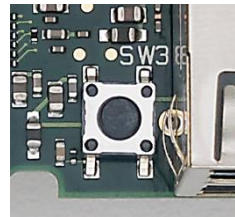

Figure 7-3 Reset Button

SW3 is connected to the reset input of a MAX6751KA29 chip via additional logic. The resulting open drain reset signal is then inverted and fed to the microcontroller.

The following table shows the internal connections:

SW3		J17	ST4		Microcontroller	
Pin	Signal	Pin	Pin	Signal	Pin	Name
1 & 3	+3,3V					
2 & 4	RST-BTN (\$39166)	→ 1				
		7	→ T136	RST-IN#	→ 52	PTC7

Table 7-5 Reset button pinout

8 LEDs

8.1 RJ45 LEDs

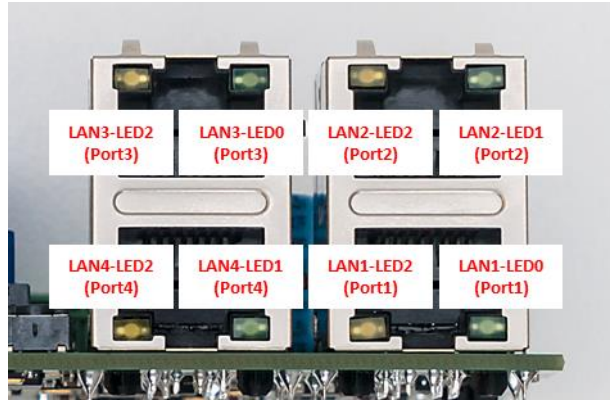

Figure 8-1 RJ 45 LEDs

The following table summarizes the RJ45 LEDs of the SBC-LS1046A:

Part Reference	Source	Signal Name	Function
LAN1-A	J8	LAN1-LED0	Green LED: configurable Default: 3 blinks – 1000Mbps / 2 blinks – 100 Mbps / 1 blink – 10 Mbps / 0 blinks – no link
LAN1-A	J8	LAN1-LED2	Yellow LED: off
LAN1-B	J10	LAN2-LED1	Green LED: configurable Default: On = Link / Off = no Link / Blink = Activity
LAN1-B	J10	LAN2-LED2	Yellow LED: off
LAN2-B	J12	LAN3-LED0	Green LED: configurable Default: 3 blinks – 1000Mbps / 2 blinks – 100 Mbps / 1 blink – 10 Mbps / 0 blinks – no link
LAN2-B	J12	LAN3-LED2	Yellow LED: off
LAN2-A	J14	LAN4-LED1	Green LED: configurable Default: On = Link / Off = no Link / Blink = Activity
LAN2-A	J14	LAN4-LED2	Yellow LED: off

Table 8-1 Indicator LEDs

8.2 Power And Reset LEDs

Part Reference	Source	Signal Name	Function
LD1	ST3	VEXT	Power (VEXT) On
LD2	ST4	CB-RST#	Carrier board reset active
LD3	J17 / SW3	RST-IN#	<ul style="list-style-type: none"> • Power on the carrier is not ok • watchdog reset is active • manual reset is triggered

Table 8-2 Indicator LEDs – Carrier board

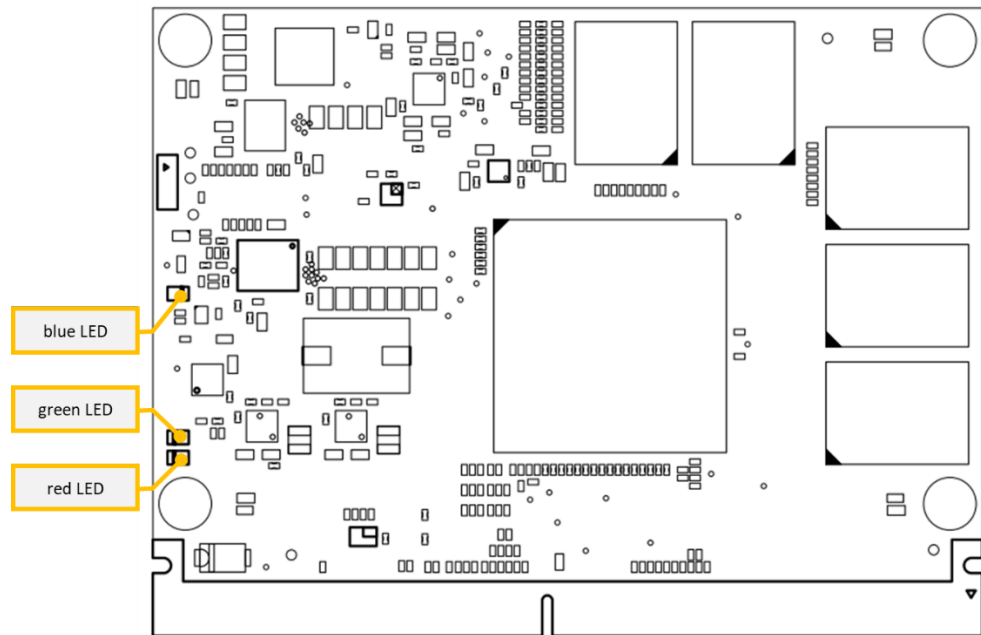

Colour	Function
Green	LED ON: Power-up sequence of the module is finished, power is good LED OFF: Power fail
Red	LED ON: Module reset is active LED OFF: Reset is inactive
Blue	General Purpose LED

Table 8-3 Indicator LEDs – Module

8.3 RGB LEDs

The SBC-LS1046A provides a RGB LED driver controlling four RGB LEDs.



I²C address 0x68 is existing twice on I2C-1 bus.

Therefore, the so-called “All Call I2C address” of the TLC59116IRHBR RGB LED driver has to be disabled before GP input pins of the MAX7325 port expander can be read correctly. This can be achieved by setting the default value 1 of Bit 0 in MODE1 register to 0.

The following table shows how the LEDs are mapped to the driver outputs:

Part Reference	LED Driver Output	LED Output Register
LD4	LED0	0x14
	LED1	
	LED2	
	LED3 is not connected	
LD7	LED4	0x15
	LED5	
	LED6	
	LED7 is not connected	
LD6	LED8	0x16
	LED9	
	LED10	
	LED11 is not connected	
LD5	LED12	0x17
	LED13	
	LED14	
	LED15 is not connected	

Table 8-4 Indicator LEDs – Mapping

9 Software

9.1 U-Boot

The SBC-LS1046A uses a U-Boot as standard boot loader, which is integrated in the board's QSPI Flash memory on delivery. NAND boot is not any longer recommended due to reliability and thus not included in standard delivery.

Additionally, there's a U-Boot version available to be placed on microSD card, if both other boot options should fail for some reason.

Either boot option can be selected by the Boot Device Switch (see chapter 7).

9.2 Operating System Support

MicroSys Electronics GmbH offers Linux and Microware OS-9 RTOS support for the board.

Other Operating Systems are available on request only.

If you should have ordered a Starter Kit, the most recent Linux will already be installed in the board's flash, so you can start to develop and test your application right away.

10 Appendix

10.1 Acronyms

These acronyms are being used within the document; note that this list does not claim to be complete or exhaustive:

<i>CPU</i>	<i>Central Processing Unit</i>
<i>DC</i>	<i>Direct Current</i>
<i>DDR4</i>	<i>Double Data Rate Memory fourth-generation</i>
<i>EC</i>	<i>Ethernet Controller</i>
<i>ESD</i>	<i>Electrostatic Discharge</i>
<i>Gbps</i>	<i>Gigabit per second, Gigabit per second</i>
<i>GND</i>	<i>Ground</i>
<i>GPL</i>	<i>General Public License</i>
<i>I2C</i>	<i>Inter-Integrated Circuit</i>
<i>JTAG</i>	<i>Joint Test Action Group</i>
<i>LAN</i>	<i>Local Area Network</i>
<i>LED</i>	<i>Light Emitting Diode</i>
<i>LVTTL</i>	<i>Low Voltage Transistor–Transistor Logic</i>
<i>MCU</i>	<i>Microcontroller Unit</i>
<i>MMC</i>	<i>Multimedia Card</i>
<i>mPCIe</i>	<i>Mini Peripheral Component Interconnect Express</i>
<i>mSATA</i>	<i>Mini Serial Advanced Technology Attachment</i>
<i>RGMI</i>	<i>Reduced Gigabit Media-independent Interface</i>
<i>RTC</i>	<i>Real Time Clock</i>
<i>SBC</i>	<i>Single Board Computer</i>
<i>SD</i>	<i>Secure Digital</i>
<i>SDIO</i>	<i>Secure Digital Input Output</i>
<i>SDRAM</i>	<i>Synchronous Dynamic Random Access Memory</i>
<i>SerDes</i>	<i>Serializer/Deserializer</i>
<i>SOM</i>	<i>System On Module</i>
<i>UART</i>	<i>Universal Asynchronous Receiver Transmitter</i>
<i>USB</i>	<i>Universal Serial Bus</i>

10.2 Table of Figures

Figure 3-1 System setup example (LAN port 4)	12
Figure 4-1 Block Diagram (MPX-LS1046A Revision 2 on carrier CRX05 Revision 2).....	15
Figure 4-2 Mechanical Dimensions Modul	17
Figure 4-3 SBC-LS1046A Mechanical Dimensions	18
Figure 4-4 Top connectors	19
Figure 4-5 Bottom connectors	20
Figure 4-6 Power supply structure	22
Figure 5-1 Reset Structure (carrier CRX05 Revision 2)	24
Figure 7-1 Boot Device Switch.....	60
Figure 7-2 Board Configuration Switch	61
Figure 7-3 Reset Button	62
Figure 8-1 RJ 45 LEDs.....	63

10.3 Table of Tables

Table 1-1 Symbols	6
Table 1-2 Conventions	6
Table 2-1 Safety and Handling Precautions	7
Table 2-2 Functional coverage.....	10
Table 4-1 Pinout ST3	21
Table 5-1 Reset signal overview	25
Table 5-2 Voltage monitoring limits (carrier).....	25
Table 5-3 Clock distribution.....	27
Table 5-4 Hard wired boot signals.....	28
Table 5-5 NAND Flash pin assignments	29
Table 5-6 QSPI Flash pin assignment.....	30
Table 5-7 I ² C1 bus map	31
Table 5-8 I ² C-1 pin assignment.....	32
Table 5-9 I ² C2 bus map	32
Table 5-10 I ² C-2 pin assignment	33
Table 6-1 Connector reference overview	34
Table 6-2 LAN / DTSEC / SerDes / RGMII assignment	35
Table 6-3 LAN Gigabit Ethernet connector pairs.....	36
Table 6-4 SerDes 1 pin assignment	36
Table 6-5 SerDes 2 pin assignment	36
Table 6-6 SerDes 3 pin assignment	37
Table 6-7 Port4 pin assignment	37
Table 6-8 PCIe SerDes assignment.....	38
Table 6-9 mPCIe Slot pinout	39
Table 6-10 mPCIe Slot SerDes 4 assignment.....	39
Table 6-11 mPCIe / mSATA Slot pinout.....	41

Table 6-12 mPCIe Slot SerDes 7 assignment..... 41

Table 6-13 PCIe Extension connector pinout (ST9)..... 42

Table 6-14 PCIe Edge Card connector SerDes 0 assignment 43

Table 6-15 PCIe Extension connector pinout (ST11) 44

Table 6-16 PCIe Edge Card connector SerDes 5 assignment 44

Table 6-17 SATA connector pin assignment..... 45

Table 6-18 microSD card slot pin assignment..... 46

Table 6-19 USB Host-Only Port 1 pin assignment 47

Table 6-20 USB Host-Only Port 2 pin assignment 48

Table 6-21 USB Host-Only Port 3 pin assignment 49

Table 6-22 UART2 pin assignment 50

Table 6-23 MCU Connector Pinout 51

Table 6-24 JTAG Connector Pinout R3..... 52

Table 6-25 JTAG Connector Pinout R2..... 53

Table 6-26 Aurora Connector Pinout..... 54

Table 6-27 Aurora Connector (ST14) Pinout..... 54

Table 6-28 GPIN connector pinout (ST16)..... 55

Table 6-29 GPOUT connector pinout (ST17)..... 56

Table 6-30 FAN connector pinout (PWE)..... 57

Table 6-31 Smart Card connector pinout (ST2) 58

Table 6-32 emBRICK connector pinout (ST18)..... 59

Table 7-1 Boot device settings 60

Table 7-2 BOOT-SELx pin assignment 60

Table 7-3 Configuration switch settings 61

Table 8-1 Indicator LEDs 63

Table 8-2 Indicator LEDs – Carrier board 64

Table 8-3 Indicator LEDs – Module..... 64

Table 8-4 Indicator LEDs – Mapping..... 65

Table 11-1 Document history 70

11 History

Date	Version	Change Description
2017-10-06	2.0	Release Version for carrier CRX05 Revision 2
2017-11-09	2.1	Added I2C1 address 0x00 in Table 5-7
2018-07-16	2.2	Table 2-2: add LED colors Operating voltage change to 9V – 30V PCIe portcount correction
2019-01-28	2.3	Added differences CRX05 carrier revision 2 to revision 3 (2.4.1)
2024-03-07	2.4	NAND Boot not any longer recommended 9.1 Removed memory layout due to frequent changes in BSP Minor spelling corrections

Table 11-1 Document history