

SoMs Arm® Architecture

miriac® MPX-S32G399A

MicroSys' 2nd Gen of System-on-Modules for vehicle networks based on the NXP® S32G77 processor

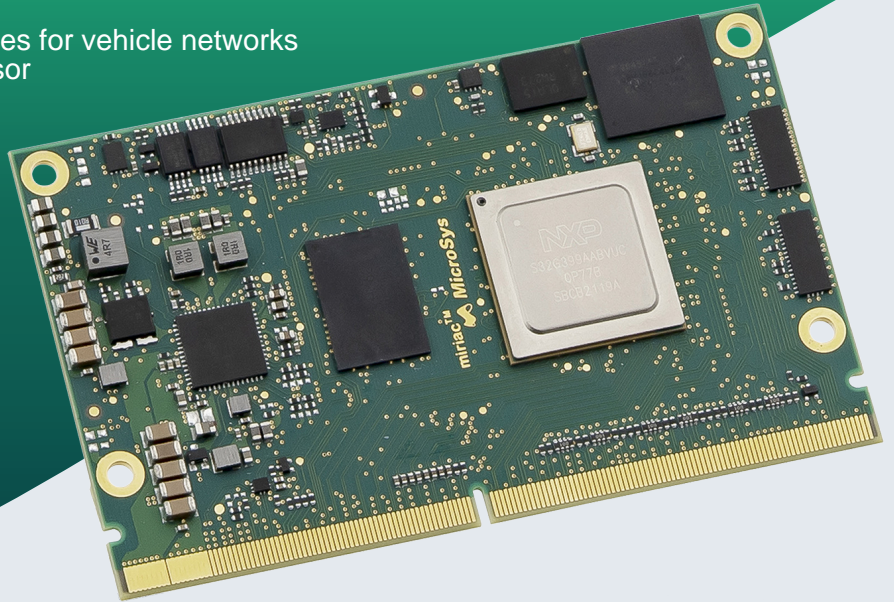

Highlights



- 8 Arm® Cortex®-A53 cores and 4 Arm® Cortex®-M7 cores including lockstep support
- Comprehensive connectivity including 18x CAN FD + dedicated protocol engine, furthermore FlexRay, LIN, SPI, Ethernet with TSN, PCI Express®, USB and I²C
- Hardware Security Engine for secure boot and accelerated security services





Product Description

Since the MPX-S32G399A System-on-Modules offer multiple native CAN interfaces, as well as FlexRay, LIN and Ethernet support, target markets include real-time connected vehicles, mobile machinery and automotive test and measurement equipment. Further application areas include data loggers, edge gateways and fail-safe programmable logic controllers (PLCs).



Features

CPU	
Architecture:	Arm® Cortex®-A53
Processor:	NXP® S32G399A CPU: 8 Arm® Cortex®-A53 64-bit cores, 4 Arm® Cortex®-M7 dual-core lockstep pairs
DRAM:	4 GB 32-bit soldered LPDDR4 RAM at 3200 MT/s
Memory	
Flash:	64 MB QSPI Flash
Flash Card:	Interface for external SD-card multiplexed with eMMC
Boot Flash:	Boot select: XSPI, eMMC or external SD card
eMMC:	Up to 32 GB
Ethernet	
RGMI:	3x
SGMI:	3x 2.5 Gbps
High Speed IO	
SerDes lanes:	4x
ULPI-USB:	1x
PCIe:	Yes
Security / Safety	
Security:	Hardware Security Engine (HSE) for secure boot and accelerated security services
Safety:	- Advanced hardware and software for safety applications - Optional: Certification Kit - Optional: AEC-Q100 Grade 3 (or I): -40°C to 85°C
Operating Condition	
Power Supply Voltage:	Single DC power input (+9 V to +36 V)
Optional Power Supply Voltage:	Single DC power input (+6 V to +36 V)
Power Management:	Yes
RTC:	RV-3028-C7
Temperature:	0 °C to 70 °C
Optional Extended Temperature:	-40 °C to 85 °C
Mechanical	

Dimensions:	82 mm x 50 mm
Connector Type:	MXM3.0
Software / Additional	
Software Support:	<ul style="list-style-type: none"> - Linux - VxWorks (on request) - Others (on request)
Additional:	<ul style="list-style-type: none"> - All I/O pins available on 314-pin edge connector - Low Latency Communication Engine (LLCE) for vehicle networks acceleration - Packet Forwarding Engine (PFE) for Ethernet networks acceleration - Dev Kit available for immediate start, includes power supply, cables. Linux on SD card

General Note:

Our standard product versions offer what we consider to be the optimum configuration in terms of performance, price, usage and TDP. The product features lists specify the maximum range of functions per interface. However, not all interfaces or functions are always available in parallel. Flexible SERDES multiplexing is one of the reasons for this. In addition, we provide multiple memory expansion options and are also happy to accommodate specific customer wishes. So do not hesitate to [contact us](#) directly to discuss your desired configuration.



Block Diagrams

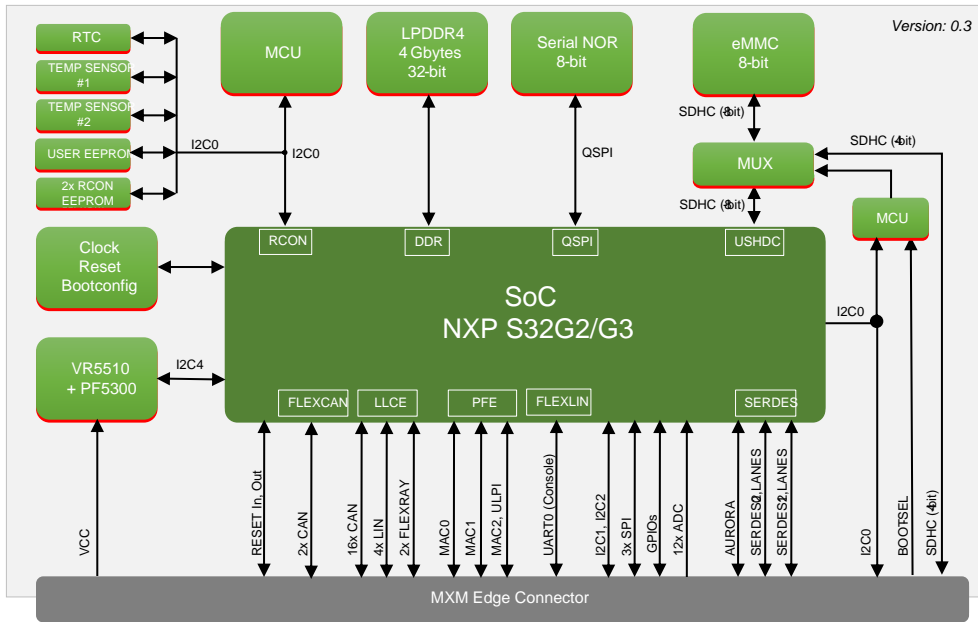

miriac® MPX-S32G3

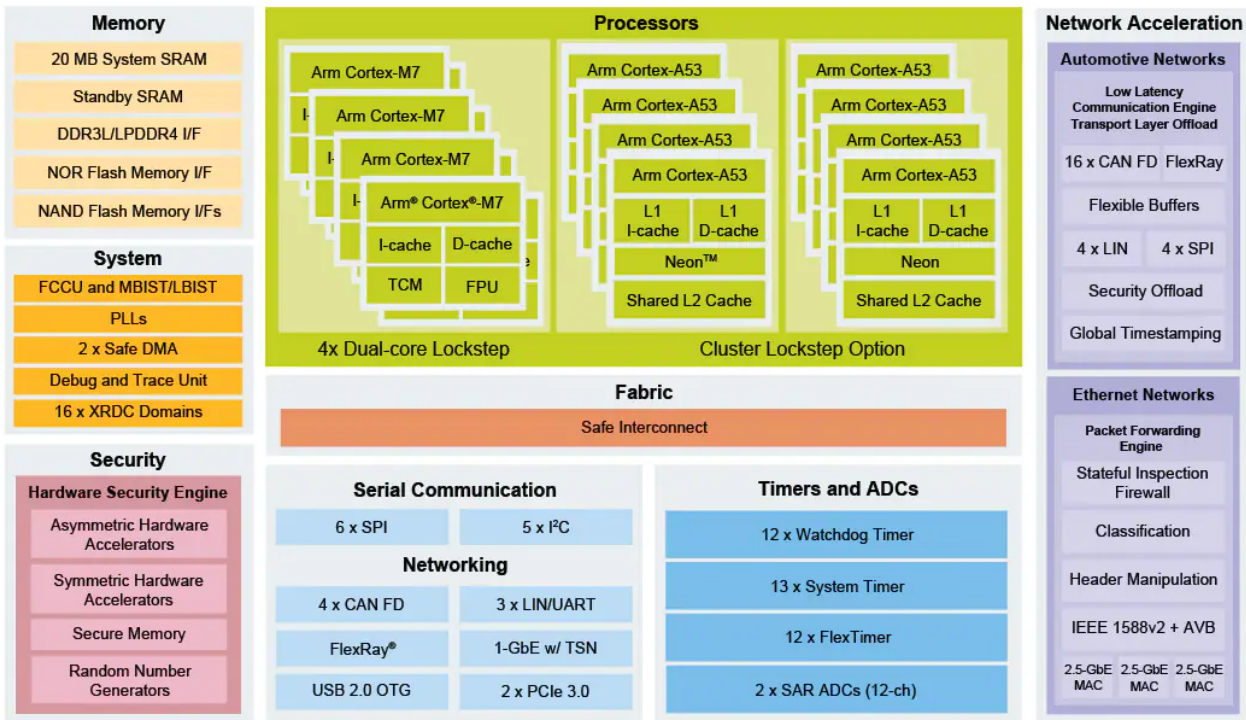

NXP® S32G399A







Order Info

Name	Code	Description	Status
miriac® MPX-S32G399A	861703	8 Arm® Cortex®-A53, 1.3 GHz, 4 GB LPDDR4 w ECC, 64 MB NOR Flash, 16 GB eMMC, 0 °C to 70 °C, w SEC	active
Development Kit basic for miriac® MPX-S32G399A	8629	<ul style="list-style-type: none"> • miriac® MPX-S32G399A • CRX-S32G • incl. BSP and accessories 	active

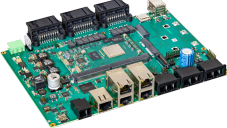

Related Products

Name	Description	Image
miriac® SBC-S32G274A	NXP® S32G274A processor based SBCs for vehicle network computing	
miriac® AIP-S32G274A	High-performance embedded AI platforms	
miriac® MPX-S32G274A	Vehicle gateway platform with massive native CAN support	
miriac® AIP-S32G399A	High-performance embedded AI platforms	
miriac® SBC-S32G399A	NXP® S32G399A processor based SBCs for vehicle network computing	

MicroSys
 Creating Embedded Systems

Mühlweg 1
 82054 Sauerlach
 Germany

Sales: +49 8104 801-130
 E-Mail: info@microsys.de
www.microsys.de

